

Examination and Treatment
Barrier Protection
Sterilization
Impression Accessories



www.dochem.biz

SHANGHAI DOCHEM INDUSTRIES CO., LTD.

Suite 2701-04
No.7, Fu Li Building
Lane 1306, Jiangning Road
Shanghai 200060, China

Tel. +86-21 6277 4584 / 6277 9265
+86-21 6277 9367
Fax +86-21 6277 6590
E-mail info@dochem.biz / dochem@sh163.net

CATALOGUE 2018

Manufacturer of
Dental Disposable Products

About Us

Value return

Ever since it was found, Dochem has recognized that our success depends on our customers. Today, a tradition of quality and service remains the cornerstone of our business. The consistency of the quality of our products along with the support we offer both before and after the sale instill full confidence in our merchandise. Our competitive pricing allows our customers profitability to remain the focus.

Experience and innovation

Dochem is a professional manufacturer of high quality dental and medical disposable supplies, with efficient producing facilities, strict testing means, strong technical force, skilled workers, professional salesmen and flexible trade methods ensure all of our products are produced according to the international standards with reliable quality and meet our international customers any requirements.

Work with us

By co-operating with Dochem, you have selected one of the most reliable FDA, CE and ISO 13485 certified medical and dental manufacturers, Dochem is committed to enhance the product selection and quality of service, shorten lead time and assist in lowering inventory, by providing new products every year to bring in continuous and higher profits for our clients.



CERTIFICATES



上海稳兴工贸有限公司拥有此样本所有内容版权，特别对此类商标和包装设计等申请了法律保护，未经书面同意，不得进行任何形式的使用，否则将追究相关人员及公司的法律责任。

Shanghai Dochem Industries Co., Ltd. has applied for legal protection for the Logos and Designs, the whole or any part of this catalog may not be copied without permission. Dochem reserves the right to make any improvement or change on design without advance notice.

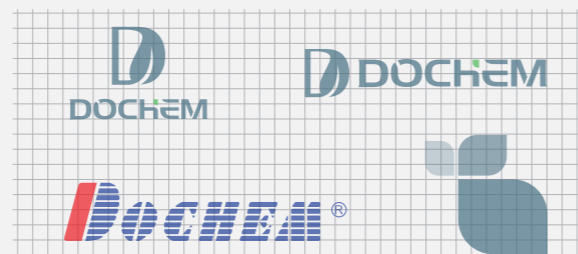

CONTENTS



PERSONAL PROTECTION

- 01 cotton roll, cotton pellet
- 02 cotton roll/pallet dispenser, holder, clip
- 03 gauze/non-woven sponge, holder
- 04-06 face mask
- 07 gown, shoe cover, cap
- 08 glasses, shield
- 09-10 dental bib, apron, bib clip
- 11 barrier kit for implantology



STERILIZATION

- 12 sterilization pouch and reel
- 13 indicator, sealing machine



ENVIRONMENTAL PROTECTION

- 14-17 plastic sleeves/sheaths/covers
- 18 headrest cover, barrier film and dispenser
- 19 disposable traps



EXAMINATION & TREATMENT

- 20 saliva ejector
- 21-22 suction tip, HVE tip, adapter
- 23 air/water syringe tip
- 24-25 syringe, needle, needle cap
- 26-27 micro applicator, dispenser, brush
- 28 mixing well, dish, mortar and pestle
- 29-30 prophy cup, brush, angle
- 31-33 mouth mirror, tweezers, probe, kit
- 34 retractor, mouth support, rubber dam cup, cup dispenser
- 35 cup, cup dispenser
- 36 articulating paper, wedge blade, suture with needle
- 37 blade, suture with needle



ENDODONTICS

- 38-39 GP, PP, endo container
- 40-41 endo file
- 42 endo foam, cassette, ruler
- 43 barbed broach
- 44 pesso reamer, gates drill, screw post
- 45 fiber post
- 46-48 endo disinfection box, ruler



IMPRESSION ACCESSORIES

- 49-50 impression tray
- 51 mixing bowl, pad, spatula
- 52 applier, activator, holder, carrier, dispenser



PREVENTATIVES / ANESTHETICS

- 53 dental needle, aspirating syringe
- 54 sharps container, waste bag, tray cover
- 54 fluoride foam tray



ORTHO. & LAB PRODUCTS

- 55-56 denture box, tooth box
- 57 ortho-use model, articulator
- 57 ortho straight teeth system
- 57 alcohol lamp
- 58 other ortho products



BLOCK/HOLDER/CONTAINER/TRAY

- 59-61 bur block, bur dispenser, bur holder
- 62 bur tub, disinfection cassette, germicide tray
- 63 cabinet tray, plastic tray, set-up tray



X-RAY ACCESSORIES

- 64 barrier envelope
- 65 x-ray film, digital imaging plate
- 66 film mounts, holder
- 67 film holding system, lead apron/collar



TEACHING MODELS

- 68-69 denture/implant/bone/extraction model



ROTARY INSTRUMENTS

- 70-73 burs, polishers, discs, mandrels, brushes



MATERIALS

- 74 synthetic/porcelain teeth
- 75-77 resin, acrylic, wax, wax wire, alginate, stone
- 78-79 matrix band, cement, eugenol, alloys



EQUIPMENTS

- 80-81 curing light and accessories
- 82 intraoral camera, intraoral LED lighting
- 83 disposable high-speed handpiece
- 84-85 ultrasonic scaler and tip
- 86-88 endodontic treatment ultrasonic cleaner
- 89-90 amalgamator
- 91 autoclave
- 92 alginate mixer, water distiller
- 93 prophy jet, handpiece lubrication system
- 95-98 x-ray unit
- 99 air compressor

COTTON ROLLS



FEATURES:

- 100% highly absorbent cotton, pure white
- Flexibility, conforms easily, maintains its shape when wet
- No cellulose or rayon fibers
- No metal, glass, grease
- Will not adhere to mucous membranes
- Well-packed for protection



Bag Package

Ref.	Description	Pcs / Bag	Bags / Case
1A0001	#1 0.8cm x 3.8cm	1000 pcs / bag	20
1A0002	#1 0.8cm x 3.8cm	2000 pcs / bag	12
1A0003	#1 0.8cm x 3.8cm	750 pcs / bag	40
1A0011	#2 1.0cm x 3.8cm	1000 pcs / bag	20
1A0012	#2 1.0cm x 3.8cm	2000 pcs / bag	12
1A0013	#2 1.0cm x 3.8cm	600 pcs / bag	40
1A0015	#2 1.0cm x 3.8cm	500 pcs / bag	48
1A0021	#3 1.2cm x 3.8cm	1000 pcs / bag	20

Box Package

Ref.	Description	Pcs / Box	Boxes / Case
1A0000	#1 0.8cm x 3.8cm	2000 pcs / box	12
1A0010	#2 1.0cm x 3.8cm	2000 pcs / box	12
1A0014	#2 1.0cm x 3.8cm	600 pcs / box	40
1A0020	#3 1.2cm x 3.8cm	2000 pcs / box	12

Order Notice:

- Two quality grades: ADVANTAGE PLUS and TOPLUS, acquiescence is ADVANTAGE PLUS
- More package types are available upon requests



DENTAL PELLETS



Ref.	Description
1A0030	Dia. 8.5mm
1A0031	Dia. 7mm
1A0032	Dia. 5.5mm
1A0033	Dia. 4mm
1A0034	Dia. 3mm
1A0035	Dia. 2.4mm



COTTON ROLLS DISPENSER

- Flip-up top for easy loading
- Holds up to 40 rolls, for size #2
- Non-skid base for easy dispensing
- Heavy duty, positive aseptic barrier
- Packing:

1A0040 and 1A0042: 1 pc / box, 50 boxes / case
 1A0041: 1 pc / box, 40 boxes / case
 1A0043-46: 1 pc / box, 30 boxes / case



Rolling Type (Autoclavable)



COTTON ROLLS HOLDER

- Made of plastic, autoclavable, with lid
- Stainless steel pins embedded in weighted bottom hold cotton roll in neat ward position
- Packing: 1 pc / box, 100 boxes / case

Ref.	Description
1A0050-G	Gray, 3-1/5"(Dia.) x 2"(H)
1A0050-B	Blue, 3-1/5"(Dia.) x 2"(H)
1A0050-Y	Yellow, 3-1/5"(Dia.) x 2"(H)

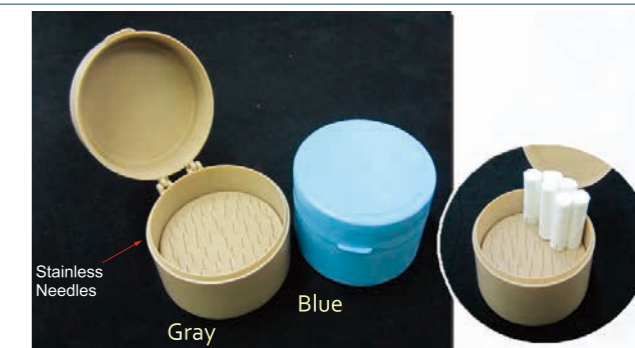

COTTON ROLL HOLDER CLIP

- Made of high quality plastic
- Disposable and works with cotton rolls to isolate teeth
- Packing: 100 pcs / bag, 40 bags / case



COTTON PELLETS DISPENSER

- White, for small pellets, spring loaded, pushes pellets to the surface
- Size: 1-7/8" x 1-7/8" x 2-1/16", 25 dispensing holes



ALL-GAUZE SPONGES

(100% HIGHLY ABSORBENT PURE COTTON) (NON-STERILE)



- Increase patient more comfort
- No chemical additives
- For multipurpose applications
- Pure, virgin 100% highly absorbent pure cotton

Mesh: 19 x 9

Ref.	Description	Pcs / Sleeve	Sleeves / Case
1A0160	2" x 2" (5cm x 5cm) 8-ply	200	25
1A0161	2" x 2" (5cm x 5cm) 12-ply	200	40
1A0162	3" x 3" (7.5cm x 7.5cm) 8-ply	200	20
1A0163	3" x 3" (7.5cm x 7.5cm) 12-ply	200	20
1A0164	4" x 4" (10cm x 10cm) 8-ply	200	20
1A0165	4" x 4" (10cm x 10cm) 12-ply	200	10
1A0166	4" x 4" (10cm x 10cm) 16-ply	200	10
1A0167	8" x 4" (20cm x 10cm) 12-ply	200	10

Mesh: 19 x 15

Ref.	Description	Pcs / Sleeve	Sleeves / Case
1A0170	2" x 2" (5cm x 5cm) 8-ply	200	25
1A0172	3" x 3" (7.5cm x 7.5cm) 8-ply	200	20
1A0174	4" x 4" (10cm x 10cm) 8-ply	200	20

GAUZE SPONGE HOLDERS



- 1A0210 Yellow
- 1A0211 Blue
- 1A0212 Green
- 1A0213 Beige
- 1A0214 White

- Keep sponge in the position ready for use
- Weighted bottom, cover included
- Steam autoclavable and chemoclavable
- Suits for size 2" x 2" (5cm X 5cm) gauze
- Packing: 1 pc / box, 100 boxes / case

COTTON-FILLED EXODONTIA SPONGES

(100% HIGHLY ABSORBENT WHITE COTTON) (NON-STERILE)



- Save time with economical multipurpose sponge
- Increased absorbency, no chemical additive
- Pure, virgin white cotton with 100% cotton-fiber filling

Ref.	Description	Pcs / Sleeve	Sleeves / Case
1A0100	2" x 2" (5cm x 5cm) 8-ply (Non-Sterile)	200	25

SAFE NON-WOVEN SWAB (SPONGE)

(HIGHLY ABSORBENT, NON-STERILIZED / STERILIZED)



- Premium quality, excellent absorption capacity, no chemical whiteners added
- Increased patient comfort with extra soft feeling, adaptable and non-irritating, even if a certain friction is required for wound cleansing
- Being easily handled, ready for use, non-adherent
- Being ideal for wound cleansing, coverage, isolation, protection from lesions

Ref.	Description	Pcs / Sleeve	Sleeves / Case
1A1600	30g/m ² , 2" x 2" (5cm x 5cm) 4-ply	200	50
1A1601	30g/m ² , 3" x 3" (7.5cm x 7.5cm) 4-ply	200	50
1A1602	30g/m ² , 4" x 4" (10cm x 10cm) 4-ply	200	40
1A1603	30g/m ² , 4" x 3" (10cm x 7.5cm) 4-ply	200	40
1A1604	40g/m ² , 2" x 2" (5cm x 5cm) 4-ply	200	50
1A1605	40g/m ² , 3" x 3" (7.5cm x 7.5cm) 4-ply	200	50
1A1606	40g/m ² , 4" x 4" (10cm x 10cm) 4-ply	200	40
1A1607	40g/m ² , 4" x 3" (10cm x 7.5cm) 4-ply	200	40

SENSITIVE Earloop Face Mask



Extra gentle to skin

Features

- White hypoallergenic cellulose inner layer
- Extra soft and comfortable
- Free of chemicals, latex and fiberglass
- Easy breathability
- Packing: 50 pcs / box, 40 boxes / case

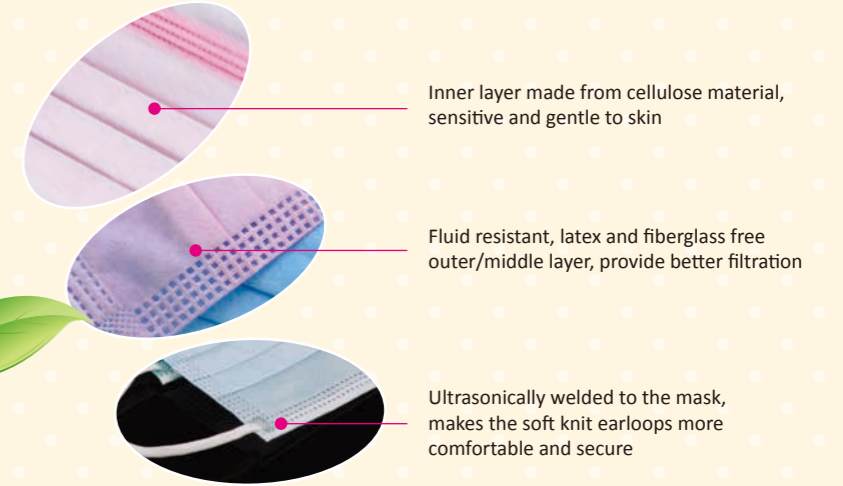

- Blue 1A3100-SES
- Green 1A3101-SES
- White 1A3102-SES
- Pink 1A3103-SES
- Yellow 1A3104-SES



PRINTED Earloop Face Mask



Features

- 3-ply, comfortable design
- Printed fluid resistant Polypropylene outer layer
- Meltblown filtration middle layer
- Silk-like, ultra-soft white inner layer
- 100% latex, fiberglass free hypoallergenic material
- Long length PVC-concealed nose piece
- More printings available upon requests

HIGH  LOW
PROTECTION LEVEL



WELDING POINT
·Ultrasonically welded to the mask, makes the soft knit earloops more comfortable and secure

FLAT EARLOOP
·Flat earloop provides comfort even wear for a long time

INNER LAYER
·Soft, special designed material to reduce skin irritation and allergic reactions
·All days comfort provided

FILTER
·Highest quality filter media for best ASTM rating, filtration value and breathability

OUTER LAYER
·Added protection with unique material for maximum fluid resistance / protection against body fluids

TOPSAFE EARLOOP FACE MASK Meets all current ASTM 2100 performance criteria.

CLASSIFICATION	TYPE IIR EN14683	BFE(%)	PFE(%)	DELTA P (H ₂ O/CM ²)	MM Hg [☆]	FLAME SPREAD
TOPSAFE ELITE	○	≥99.8	≥99.3	<5.0	160	Class I
TOPSAFE PLUS	○	≥98.0	≥99.3	<5.0	160	Class I
DISMED PREMIER	△	≥95.0	≥98.9	<4.0	80	Class I

○ TYPRE IIR EN14683 certified △ None ☆ Resistance to penetration by synthetic blood



Earloop Face Mask Ref. Codes			
COLOR	TOPSAFE ELITE	TOPSAFE PLUS	DISMED PREMIER
BLUE	1A3100	1A3105	1A3110
GREEN	1A3101	1A3106	1A3111
YELLOW	1A3102	1A3107	1A3112
PINK	1A3103	1A3108	1A3113
WHITE	1A3104	1A3109	1A3114

More colors are available upon requests. (e.g.: **Pale Green, Purple**)
Packing: 50 pcs / box, 40 boxes / case



TOPSAFE ELITE SURGICAL TIE-ON FACE MASK

Premium Elite

- BFE: ≥99.8% PFE: ≥99.3% Delta P(H₂O/CM²) <5.0
- Resistance to penetration by synthetic blood (mmhg): 160
- Flame spread: Class I
- Packing: 50 pcs / box, 40 boxes / case

Ref.	Color
1A3130	Blue
1A3131	Green
1A3132	White
1A3133	Pink
1A3134	Yellow



TOPSAFE PLUS PRO-SHIELD MASK

- Two-in-One protection with combination face mask and eye shield
- Fluid resistant, added protection with unique shingle pleat design, the highest bacterial filtration
- Optically clear shield, latex-free
- Both earloop and tie-on mask are available
- Packing: 50 pcs / box, 20 boxes / case

Ref.	Description
1A3150	Fog-Free, blue normal plastic shield
1A3152	Fog-Free, green normal plastic shield

CHILD FACE MASK

Earloops, for children

Ref.	Color
1A3120	Blue
1A3121	Green
1A3122	Yellow
1A3123	Pink
1A3124	White



- Ideal for sensitive skin due to latex-free materials
- BFE over 98%
- Suitable for children over 7 years old
- Packing: 50 pcs / box, 40 boxes / case

PREMIUM CONE MASK

- Comfort and breathability, with molded contour design
- Packing: 50 pcs / box, 20 boxes / case

Ref.	Description
1A3140	Blue
1A3141	White





LAB GOWNS

- Protects against cross-contamination
- Non-woven, increased breathability
- Fluid resistant, non-irritating
- Packing: 10 pcs / bag, 5 bags / case

Material Weight (Non-woven) : 38 GSM
More choices of materials available, e.g. 30 GSM

Ref.	Description
1A2740	Small, Elastic Cuff
1A2741	Small, Knit Cuff
1A2742	Medium, Elastic Cuff
1A2743	Medium, Knit Cuff
1A2744	Large, Elastic Cuff
1A2745	Large, Knit Cuff
1A2746	X-Large, Elastic Cuff
1A2747	X-Large, Knit Cuff



BOUFFANT CAP

- Super protection with fluid repellent material
- Comfort and ventilation
- Reduced allergic reactions with Latex-free elastic headband
- Packing: 100 pcs / bag, 20 bags / case



TIE-BACK DISPOSABLE ISOLATION GOWNS

- Added protection against cross-contamination
- Comfortable fit with cuffs, neck ties and ties on back
- Fluid resistant, non-irritating, knee length
- Colors available: blue, green, yellow, white
- Packing: 10 pcs / bag, 10 bags / case

Material Weight (Non-woven) : 38 GSM
More choices of materials available, e.g. 30 GSM

Ref.	Description
1A2790	Regular size, Elastic Cuff
1A2791	Regular size, Knit Cuff
1A2792	Medium size, Elastic Cuff
1A2793	Medium size, Knit Cuff
1A2794	Large size, Elastic Cuff
1A2795	Large size, Knit Cuff

SHOE COVER

- Super protection with fluid repellent material
- Easy to use with elastic opening, easy to slip on

Ref.	Description
1A2720	Non-woven, regular size
1A2726	Non-woven, premier, skid-proof, regular size
1A2728	PE material, regular size
1A2729	PE material, X-large size
1A2730	CPE material, skid-proof, regular size



Ref.	Description	Ref.	Description
1A2700	18"(46cm), white	1A2704	21"(51cm), white
1A2701	18"(46cm), green	1A2705	21"(51cm), green
1A2702	18"(46cm), blue	1A2706	21"(51cm), blue
1A2703	18"(46cm), pink	1A2707	21"(51cm), pink

HIGH IMPACT RESISTANT SAFETY GLASSES

MOTOR TYPE/FIXED LEG



- Polycarbonate, comfortable, good ventilate side
- Spectacle frame and lens are integrated designed
- No metal accessories, comfortable for wearers
- Broad vision and with good side vision
- **UV400 protection**, non-fogging is optional
- Fits comfortable over short sight spectacles

Ref.	Description
1A3330	Clear lens and leg
1A3331	Yellow lens and leg
1A3332	Black lens and leg
1A3333	Orange lens and leg
1A3334	Red lens and leg

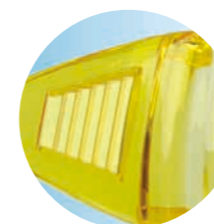

- **Individual Packing:** 1 pc / box, 100 boxes / case
- **Economic packing:** 10 pcs / box, 20 boxes / case
- The ref. code is "-A" after each ref. code in the above form, such as "1A3330-A".

LEG ADJUSTABLE



- Polycarbonate, distortion Free Lens with sideshields
- Light weight, comfortable to wear, with complete side and brow protection
- Adjustable temple length settings in 4 different positions with integrated stop lock
- **Maximum UV 400 Protection**
- Spectacles have inclination adjustments

Ref.	Description
1A3340	Clear lens, Blue leg
1A3341	Red lens, Yellow leg
1A3342	Yellow lens, Black leg
1A3343	Black lens, Black leg
1A3344	Green Lens, Red leg

- **Individual Packing:** 1 pc / box, 100 boxes / case
- **Economic packing:** 10 pcs / box, 20 boxes / case
- The ref. code is "-A" after each ref. code in the above form, such as "1A3340-A".



Ref. 1A3310

FULL FACE SHIELD

- Fog-free design, disposable shield provides full-face protection
- Vented sponge cushion absorbs sweat
- 100% optically clear, plastic barrier
- Comfortable non-latex band eliminates pressure points
- Fits over glasses and face masks
- Packing: 10 pcs / bag, 20 bags / case



Ref. 1A3314

EYEWEAR FACE SHIELD

- Eyes frame designed fits most face



Ref. 1A3300

SAFETY EYEWEAR

- Provides extra safety, multiple use and versatile
- Used in conjunction with ear-loop mask will provide complete protection from sprays and debris to facial area.
- Packing: 50 pcs / box, 10 boxes / case

DENTAL BIBS

Wide-Cover

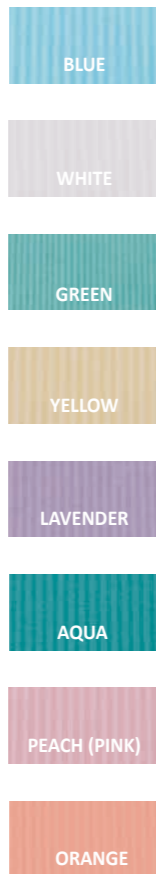

BIBS WITH TABLE-ON DESIGN

- Special box design for easy table-on and bibs taken out
- Dust-free with cover down after opening
- 2-ply paper + 1-ply poly
- Size: 13" x 18" (33cm X 45.5cm)
- Packing: 200 pcs / box, 8 boxes / case

Ref.	Description
1A4220	Blue
1A4221	White
1A4222	Green
1A4223	Yellow
1A4224	Lavender
1A4225	Aqua
1A4226	Peach(Pink)
1A4227	Orange

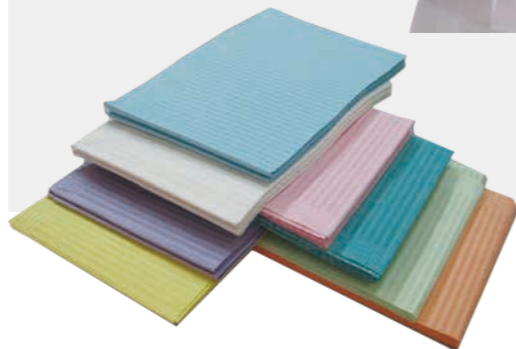

Colorful Choice!



HORIZONTAL PATTERN

- Maximum protection with horizontal embossed pattern and a unique water repellent edge
- Increased strength and tear resistance with plastic backing for added clothing protection
- Size: 13" x 18" (33cm X 45.5cm) Packing: 500 pcs / case

Thickness	Blue	White	Green	Yellow	Lavender	Aqua	Peach	Orange
2-ply paper + 1-ply poly	1A4200	1A4201	1A4202	1A4203	1A4204	1A4205	1A4206	1A4207
1-ply paper + 1-ply poly	1A4240	1A4241	1A4242	1A4243	1A4244	1A4245	1A4246	1A4247

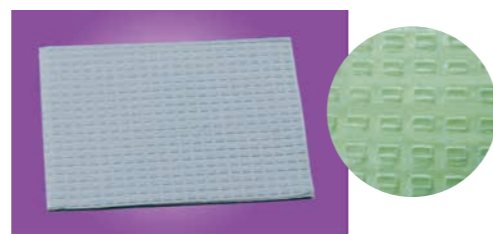

CHEQUER PATTERN

- Special embossed pattern design, luxury vision impression, premier touch feeling
- Maximum protection with horizontal embossed pattern and a unique water repellent edge
- Increased strength and tear resistance with plastic backing for added clothing protection
- Size A: 13" x 18" (33 cm x 45.5 cm) Packing: 500 pcs / case
- Size B: 13" x 9" (33 cm x 23 cm) Packing: 1000 pcs / case

Thickness	White	Blue	Green	Yellow
2-ply paper + 1-ply poly	1A4250	1A4251	1A4252	1A4253
3-ply paper + 1-ply poly	1A4254	1A4255	1A4256	1A4257



SELF-TIE BIBS

Ref.	Description
1A4403PK	Pink
1A4403BL	Blue
1A4403WH	White
1A4403GR	Green
1A4403YL	Yellow
1A4403PU	Purple

- Size: 36 cm x 45 cm
- Packing: 100 pcs / bag, 20 bags / ctn

TIE BIBS

- Ref. 1A4230-TB3
- With tough tie, U-style Collar
- Size: 45 cm x 38 cm
- Packing: 500 pcs / ctn



WIDE-TIE BIBS

Ref.	Description
1A4404PK	Pink
1A4404BL	Blue
1A4404WH	White
1A4404GR	Green
1A4404YL	Yellow
1A4404PU	Purple

- With wide-tie, U-style collar
- Size: 45 cm x 33 cm
- Packing: 100 pcs / bag, 20 bags / ctn

CONTOUR BIBS

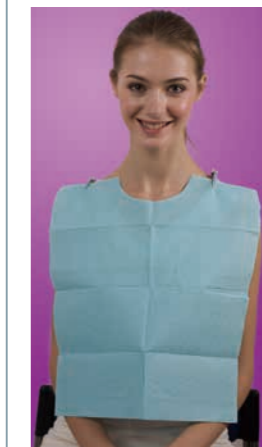

- U-Style
- 2-PLY TISSUE W / POLY
- Packing: 500 pcs / case

Ref.	Description
1A4230	Blue
1A4231	White
1A4232	Green
1A4233	Yellow
1A4234	Lavender
1A4235	Aqua
1A4236	Peach(Pink)
1A4237	Orange

DENTAL APRON

- Made of tissue paper and PE film, which prevents fluid strikethrough, embossed, disposable and low-cost
- Being ideal for the dentistry use
- Colors: negotiable

Ref.	Description	Pcs / Case
1A4400	37cm x 49cm	500
1A4401	37cm x 66cm	500



CLIPS FOR BIBS



1A4302
Bib-lover,
Metal clip + silicone spring chain

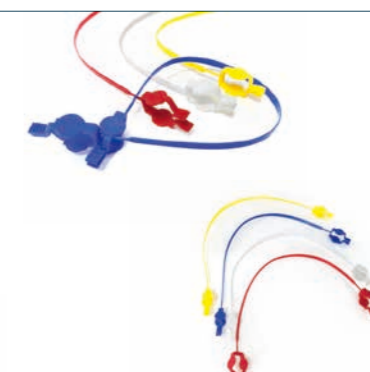

1A4300
Plastic clip + plastic chain
Packing: 20 pcs/bag, 40 bags/case



1A4301
Metal clip + metal ball chain



1A4303
Helix string,
Metal clip + silicone chain

BARRIER KITS FOR IMPLANTOLOGY

- Designed sterile kits is ideal for short routine procedure
- Professional protection for both surgeon and patient
- Improved material, anti-water, anti-blood and anti-dirt

Custom-tailor kits are welcome.

**STERILE
PACKING**

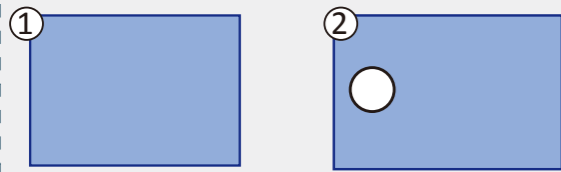

ImplanAccord (Ref. 1A6178)

- 1 Table cover (80 cm x 100 cm) x 1
- 2 Fenestrated drape (150 cm x 180 cm) x 1
- 3 Tie-on face mask x 2
- 4 Plastic tubing sleeve with adhesive (8 cm x 180 cm) x 2
- 5 Surgical cap x 2
- 6 Isolation gown x 2
- 7 Shoe cover x 2
- 8 Towel (40 cm x 30 cm) x 2

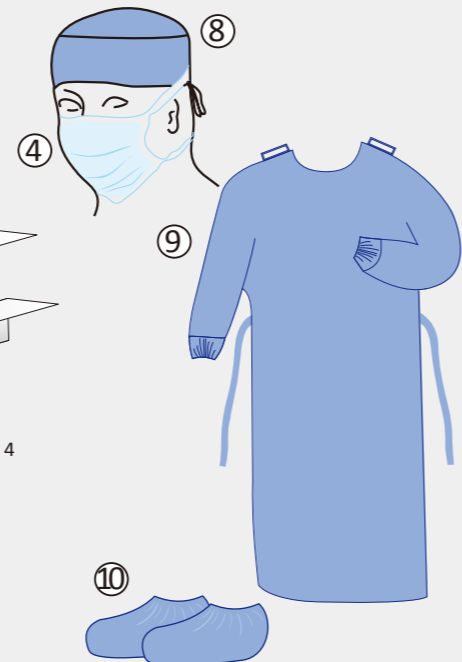
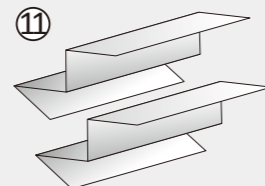
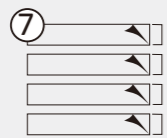
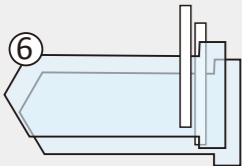
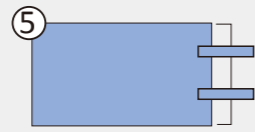
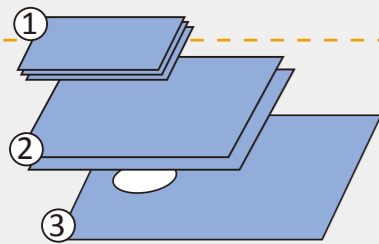
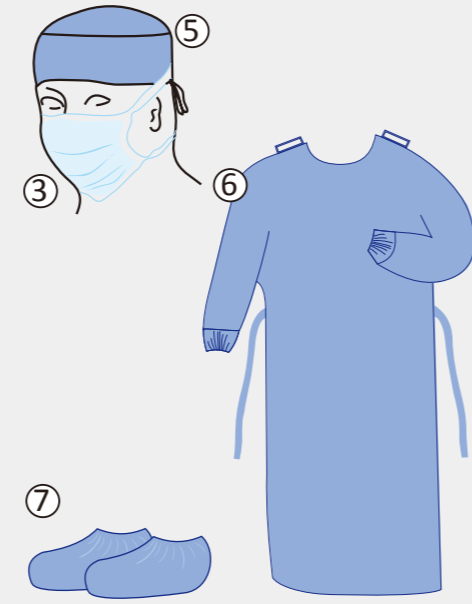
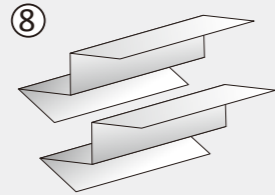
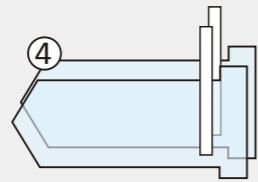

ImplanPlus (Ref. 1A6179)

- 1 Drape (60 cm x 80 cm) x 3
- 2 Impermeable table cover (120 cm x 120 cm) x 2
- 3 Fenestrated drape (160 cm x 170 cm) x 1
- 4 Tie-on face mask x 2
- 5 Suture bag (30 cm x 16 cm) x 1
- 6 Plastic tubing sleeve (8 cm x 180 cm) x 2
- 7 Double sided tape (2 cm x 20 cm) x 4
- 8 Surgical cap x 2
- 9 Isolation gown (thick material) x 2
- 10 Shoe cover in pairs x 2
- 11 Towel x 2

STERILIZATION

TOPSTERI

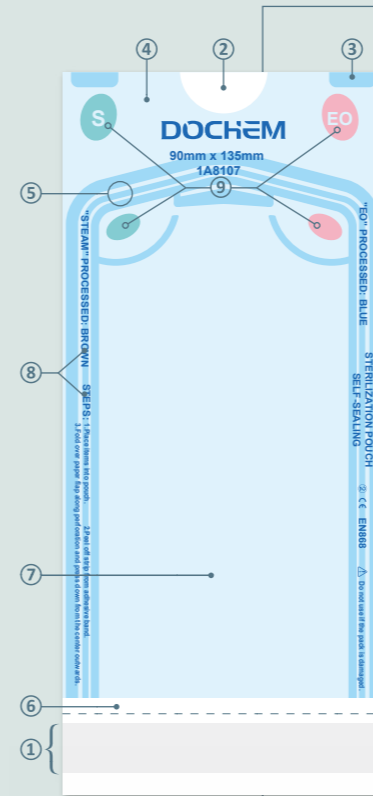

- 1 **WIDE SELF-SEAL ADHESIVE STRIP**
Ensures reliable closing without using the sealing machine
- 2 **THUMB NOTCH**
Assures pouch opened easily
- 3 **WIDE SAFETY SEALS**
Resist collection of dust, prevents corners from curling
- 4 **COMPLETE PAPER-FILM SEPARATION**
High grade materials to ensure clean and complete separation of paper and film
- 5 **TRIPLE SEAL LINES**
Enhanced three separate heat sealed rails secure edges from separation or tearing by instruments
- 6 **MEDICAL GRADE PAPER**
Meets or exceeds medical sterilization pouch standards
- 7 **TRANSPARENT FILM**
Allows easy identification of the items inside
- 8 **CLEAR PRINTINGS**
All prints are placed outside of the filling space which eliminates the possibility of paint contact with items in the package
- 9 **PROCESS INDICATORS**
Indicator color changes with STEAM or EO sterilization agent

TOPSTERI SELF-SEALING STERILIZATION POUCHES

Ref.	Description	Pcs / Box	Boxes / Case
1A8100	2-1/4" x 4" (57mm x 100mm)	200	60
1A8101	3-1/2" x 9" (90mm x 230mm)	200	20
1A8102	5-1/3" x 10" (135mm x 255mm)	200	15
1A8103	7-1/2" x 13" (190mm x 330mm)	200	7
1A8104	10" x 14-1/2" (250mm x 370mm)	200	5
1A8105	12" x 15" (305mm x 380mm)	200	5
1A8106	2-3/4" x 9" (70mm x 230mm)	200	25
1A8107	3-1/2" x 5-1/4" (90mm x 135mm)	200	30

Other sizes are available.



TOPSTERI HEAT-SEALING FLAT STERILIZATION REELS

Ref.	Description	Rolls or Boxes per Case
1A8144	2" x 655' (50mm x 200m)	6
1A8140	2-1/5" x 655' (55mm x 200m)	8
1A8141	3" x 655' (75mm x 200m)	4
1A8142	4" x 655' (100mm x 200m)	5
1A8143	6" x 655' (150mm x 200m)	2
1A8145	8" x 655' (200mm x 200m)	2
1A8146	10" x 655' (250mm x 200m)	2
1A8147	12" x 655' (300mm x 200m)	2
1A8148	8" x 1150' (200mm x 350m)	1

Other sizes are available, e.g. 100 m length.

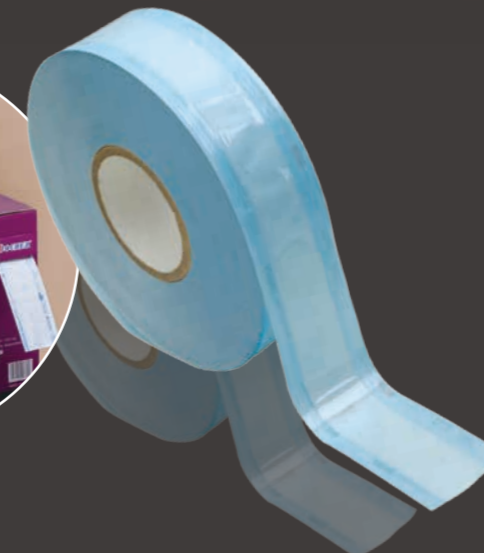

STERILIZATION

AUTOCLAVE INDICATOR TAPE

- Indicates the process of the sterilization and judges the effect of the steam sterilization
- Easily remove and tear
- Printed on the top with special indicator

Ref.	Description	Rolls / Case
1A8200	12.5mm x 50m	180
1A8201	19mm x 50m	117
1A8202	25mm x 50m	90



EO STERILIZATION INDICATOR

- Stable indicator material
- Especially for EO sterilization course
- Indicators changing color clearly after sterilization

Ref.	Description	Pcs / Sheet
1A8203	Indicator	40



Ref. 1A8215 (320 mm)

SEALING MACHINE

- Firm sealing, solid and durable, sharp blade
- Short sealing time, invariable temperature
- Automatic seal, adjustable temperature



Smart SEALING MACHINE

• 300 MM LENGTH

Ref.	Description
1A8214	Metal with paint(without temperature digital display)
1A8214-M	Stainless steel(without temperature digital display)
1A8216	Metal with paint, temperature digital display
1A8216-M	Stainless steel, temperature digital display

• 400 MM LENGTH

Ref.	Description
1A8218	Metal with paint(without temperature digital display)
1A8218-M	Stainless steel(without temperature digital display)
1A8219	Metal with paint, temperature digital display
1A8219-M	Stainless steel, temperature digital display

Environmental Protection

Dispro-barrier™ #2 INFECTION CONTROL BARRIER

- Disposable use only
 - For air motor and air/water syringe use
 - Convenient dispensing with designed dispensing-slot cover
 - 18" x 2.2" perforated sheets, 250 disposable shields / roll
- Ref. 1A6300

Dispro-barrier™ #3 INFECTION CONTROL BARRIER

- Disposable use only
 - For tubing, air turbine and scaler head use
 - Convenient dispensing with designed dispensing-slot cover
 - 18" x 1.8" perforated sheets, 250 disposable shields / roll
- Ref. 1A6301

Dispro-barrier™ #4 INFECTION CONTROL BARRIER

- Disposable use only
 - For headrests and X-ray heads use
 - Convenient dispensing with designed dispensing-slot cover
 - 11.8" x 9" perforated sheets, 250 disposable shields / roll
- Ref. 1A6305

Dispro-barrier™ #5 INFECTION CONTROL BARRIER

- Disposable use only
 - For half chair use
 - Convenient dispensing with designed dispensing-slot cover
 - 27.5" x 24" perforated sheets, 225 disposable shields / roll
- Ref. 1A6311



Ref. 1A6305

Ref. 1A6300

Ref. 1A6301

EZ-Den Tubing and Handpiece Sleeves



- Paperboard inside, unroll the sleeve without touching the tube and handpiece, avoid infection
- LDPE material, transparent to get a clear view

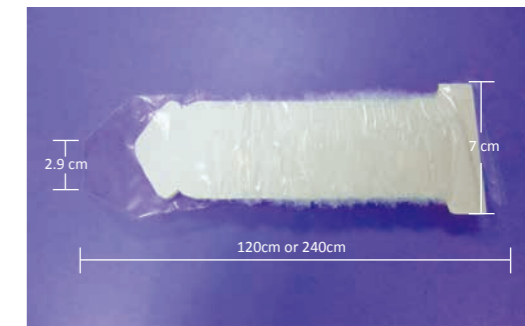

Ref.	Description	Packing
1A6430	120cm x 7cm	500 pcs / case
1A6430-L	240cm x 7cm	500 pcs / case



FOR REF. NO., PLEASE REFER TO PAGE 17 >>>

BARRIER PROTECTION

SCALER HANDLE SLEEVES



HANDPIECE SLEEVES

- Protect handpiece, save cost



INTRAORAL CAMERA SHEATHS



CURING LIGHT GUIDE SLEEVES



SYRINGE SLEEVES

- Protect syringe, save cost
- Clean, barrier covers the syringes, with opening slot

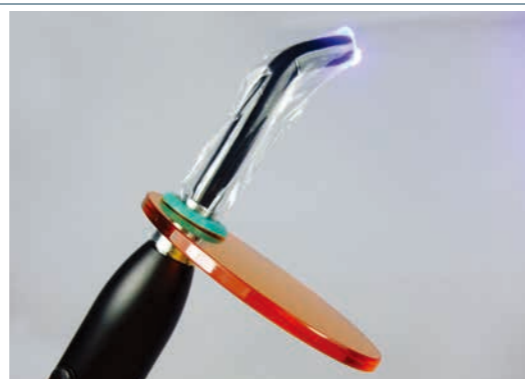

X-RAY SENSOR COVER

- A disposal cover for the sensor on digital imaging system x-ray
- Fits Trophy and Gendex system



HEADREST COVER

- Easy to place and remove, time-saving
- Reducing the change of cross-contamination
- Protect the chair headrest in good condition



X-RAY HEAD SLEEVES

- Protect your X-ray unit, save cost



OPTICAL MOUSE SHEATHS

CHAIR SLEEVES

- Protect your dental chair from dirty, save your cost
- Reduce cross infection from infectious spray



TRAY SLEEVES

- Clean and easy to use, reduce contamination and eliminate cleaning works, with overlapped locking



SLEEVES FOR T-STYLE LIGHT HANDLE

- Protect T-style light handle, keeps sleeve from falling off while in use, but easy to be removed
- Disposable, easy to slip on, provides good protection

CURING LIGHT SLEEVES for bubble machine

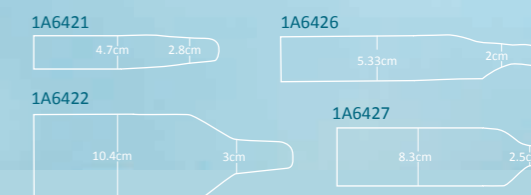

FOR REF. NO., PLEASE REFER TO PAGE 17 >>>



BARRIER PROTECTION

PLASTIC SLEEVES / SHEATHS / COVERS

All the length, width and thickness, as well as material texture can be customized.

APPLICATION	REF. CODE & DESCRIPTION (1" = 2.54cm)	PACKING
PLASTIC X-RAY SENSOR COVER	1A6400 8" x 1-5/8"	• Packing: 500 pcs / box, 36 boxes / case
	1A6401 10" x 2-1/2"	
PLASTIC SCALER HANDLE SLEEVES	1A6405 1-3/5" x 8"	• Packing: 500 pcs / box, 36 boxes / case
	1A6406 1-2/5" x 7" (with tip opening)	
DISPOSABLE INTRAORAL CAMERA SHEATHS	1A6410 9-4/5" x 2", top size: 1.0"(2.5 cm)	• Packing: 100 pcs / box, 36 boxes / case • Packing: 500 pcs / box, 36 boxes / case
	1A6411 10-1/5" x 2", top size: 8/9" (2.3 cm)	
PLASTIC CURING LIGHT / GUIDE SLEEVES	1A6413 13-2/5" x 2-1/10"	• Packing: 500 pcs / box, 36 boxes / case • Packing: 500 pcs / box, 20 boxes / case
	1A6414 13-2/5" x 3-3/10"	
	1A6415 4-1/3" x 3"	• Packing: 200 pcs / box, 42 boxes / case • Packing: 200 pcs / box, 36 boxes / case
	1A6416 4-1/3" x 3"(Diameter: 9-11 mm)	
	1A6417 4-7/8" x 1-1/5"(Paper, for light curing probe)	
PLASTIC CURING LIGHT SLEEVES FOR BUBBLE MACHINE	1A6421 9-7/8" x 1-7/8" (straight top, width 1-1/10")	• Packing: 500 pcs / box, 36 boxes / case
	1A6426 13-2/5" x 2-1/10" (curved top, width 4/5")	
	1A6422 12-2/5" x 4-1/8" (straight top, width 1-1/5")	• Packing: 250 pcs / box, 36 boxes / case • Packing: 500 pcs / box, 20 boxes / case
	1A6427 13-2/5" x 3-1/3" (curved top, width 4/5")	
PLASTIC HEAD REST COVER	1A6500 11" X 10"	• Packing: 250 pcs / box, 12 boxes / case
	1A6501 14" X 10"	
PLASTIC HANDPIECE SLEEVES	1A6505 1" x 8" (opening tip, length 2-3/4") for high-speed handpiece	• Packing: 500 pcs / box, 36 boxes / case
	1A6506 1-1/2" x 8" (tip cutting, length 1-4/7") for low speed, straight handpiece	
	1A6507 1-1/2" x 10" (the tip length 1-4/7")	
	1A6508 1.3" x 8" (the tip length 1-4/7")	
	1A6509 7-3/10" x 5" (for low speed, curved handpiece)	
PALSTIC SYRINGE SLEEVES	1A6510 2-1/2" x 10" (transparent) (tip cutting)	• Packing: 500 pcs / box, 36 boxes / case
	1A6511 2-1/2" x 20"	
	1A6512 2-1/2" x 10" (blue) (tip cutting)	• Packing: 500 pcs / box, 36 boxes / case • Packing: 1000 pcs / box, 50 boxes / case
	1A6513 1-1/4" x 4-1/2"	
PLASTIC TRAY SLEEVES(COVER)	1A6515 11-5/8" x 16"	• Packing: 500 pcs / box, 6 boxes / case
	1A6515-EX 11-5/8" x 14-1/2"	
	1A6516 10-1/2" x 14"	
	1A6516-EX 10-1/2" x 14"	
PLASTIC X-RAY HEAD SLEEVES	1A6520 30" x 24"	• Packing: 250 pcs / case
	1A6520-EX 30" x 24", extra-thick	
	1A6521 26" x 15"	• Packing: 250 pcs / box, 4 boxes / case
	1A6521-EX 26" x 15", extra-thick	
PLASTIC FULL / HALF CHAIR SLEEVES	1A6525 Full, 29" x 80"	• Packing: 125 pcs / box, 3 boxes / case
	1A6525-EX Full, 29" x 80", extra-thick	
	1A6526 Full, 48" x 56"	• Packing: 150 pcs / box, 3 boxes / case • Packing: 250 pcs / box, 3 boxes / case • Packing: 225 pcs / box, 3 boxes / case
	1A6526-EX Full, 48" x 56", extra-thick	
	1A6527 Half, 27-1/2" x 24"	
1A6527-EX Half, 27-1/2" x 24", extra-thick		
PLASTIC LIGHT SLEEVE FOR T-STYLE HANDLE	1A6530 4" x 5-3/4"	• Packing: 500 pcs / box, 36 boxes / case
	1A6531 6" x 2-9/10"	
PLASTIC DIGITAL SENSOR ENVELOPES	1A6436 2" x 4-1/2"	• Packing: 300 pcs / bag, 100 bags / case
	1A6437 1-5/8" x 4-1/7"	
	1A6438 1-5/9" x 4-1/2"	
	1A6439 1-3/8" x 4"	
PLASTIC OPTICAL MOUSE SHEATHS	1A6540 6-1/3" x 3-1/2"	• Packing: 500 pcs / box, 36 boxes / case



Non-woven

HEADREST COVER

- Save time with easy to place and remove fluid repellent material reducing cross-contamination
- Protect your dental chair from dirty, save your cost

Material: Non-woven

REF.	DESCRIPTION	COLORS AND PACKING
1A4435	Senior Material, 10" x 10"(25cm x 25cm)	Colors: Blue and Green 125 pcs / bag, 4 bags / case
1A4436	Senior Material, 10" x 13"(25cm x 33cm)	
1A4421	Soft Material, 10" x 10"(25cm x 25cm)	Colors: Blue and White 500 pcs / bag, 1 bag / case
1A4422	Soft Material, 10" x 13"(25cm x 33cm)	



Material: 1 ply paper + 1 ply poly

REF.	DESCRIPTION	COLORS AND PACKING
1A4423	10" x 10"(25cm x 25cm)	Colors: Blue, White, Yellow, Green 500 pcs / bag, 1 bag / case
1A4424	10" x 13"(25cm x 33cm)	

Material: Poly-coated non-woven

REF.	DESCRIPTION	COLORS AND PACKING
1A4425	10" x 10"(25cm x 25cm)	Colors: Blue and White 500 pcs / bag, 1 bag / case
1A4426	10" x 13"(25cm x 33cm)	

Full-Cover BARRIER FILM

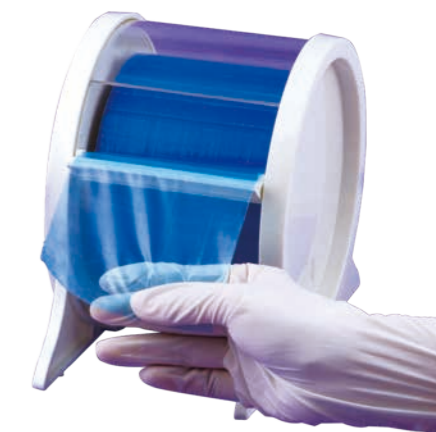

- Disposable film for surfaces that are hard to reach, clean or disinfect
- Easy to remove, reduce cross infection from infectious spray
- Convenient dispensing with special design
- Applicable to almost any surface without leaving any residue

Ref. 1A6539 BARRIER FILM DISPENSER

For wrap package film
1 pc / box, 12 boxes / case

Shrink wrap packaging, economical (1 pc / wrap, 12 wraps / case)

Size: 4" x 6" x 1200 perforated sheets

1A6535-P	Transparent, stick edges
1A6536-P	Blue, stick edges
1A6537-P	Transparent, non-stick edges
1A6538-P	Blue, non-stick edges

Plastic core with inner dispenser, with box package (1 roll / box, 8 boxes / case)

Size: 4" x 6" x 1200 perforated sheets

1A6535	Transparent, stick edges
1A6536	Blue, stick edges
1A6537	Transparent, non-stick edges
1A6538	Blue, non-stick edges

Size: 6" x 9" x 800 perforated sheets

1A6532	Transparent, stick edges
1A6533	Blue, stick edges
1A6532N	Transparent, non-stick edges
1A6533N	Blue, non-stick edges



More colors available:
Black, Yellow, Green, Orange, Pink.

DISPOSABLE TRAPS

- Disposable filter designed to replace the current trap filter in evacuation units
- Filter improves the performance of suction system and reduces the amount of infectious aerosol



1A6740-1A6741

Fits Ampco, Belmont, Biotec, Chayes, Dabi-Atlante, Dansereau, DCL, DentalEZ, Dentech, Forest, Knight, Pelton&Crane, Proma, and others (1-7/8")

Ref.	Description	Pcs / Bag	Bags / Box	Boxes / Case
1A6740	Clear white 1-7/8"	144	1	8
1A6741	Colorful 1-7/8"	144	1	8



1A6745-1A6746

Fits Adec models with black plastic canisters, plus new model by Ampco, Belmont, DCL, Forest, Marus, MDT, Biotec and Schein (2-1/8")

Ref.	Description	Pcs / Bag	Bags / Box	Boxes / Case
1A6745	Clear 2-1/8"	144	1	8
1A6746	Colorful 2-1/8"	144	1	8

1A6750-1A6751

Fits Adec models with metal canisters

Ref.	Description	Pcs / Bag	Bags / Box	Boxes / Case
1A6750	Clear 2-1/4"	144	1	8
1A6751	Colorful 2-1/4"	144	1	8



1A6755-1A6756

Fits DCI / Belmont Reality models, System 6000 models

Ref.	Description	Pcs / Bag	Bags / Box	Boxes / Case
1A6755	Clear	144	1	8
1A6756	Colorful	144	1	8

CUSPIDOR STRAINERS (WHITE)



Ref.	Description	Pcs / Bag	Bags / Box	Boxes / Case
1A6760	Fits most cuspidor bowls including: Adec, Ampco, Belmont, Dabi-Atlante, Dansereau, DCI, Dental Ez, Forest, Knight, Marus, MDT, Proma, Ritter and Schein(universal type)	144	1	8
1A6761	Fits Siemens, Planmeca, and many with small diameter openings(small type)	144	1	8

- Adapt to high volume aspirators (plastic or metal)
- Disposable & cost-efficient
- Helps prevent grasping of soft tissue and stops amalgam

Ref.	Description	Pcs / Bag	Bags / Box	Boxes / Case
1A6768	HVE Screens	144	1	60
1A6765	Saliva ejector trap	144	1	120



GUTTA PERCHA POINTS



Ref.	Description	Pcs / Box	Boxes / Case
	ISO Spec.: 15, 20, 25, 30, 35, 40		
1A2660-A	Slide Pack (A)	120	600
1A2660-B	Square Tube Pack (B)	120	400
	ISO Spec.: 45, 50, 55, 60, 70, 80		
1A2661-A	Slide Pack (A)	120	600
1A2661-B	Square Tube Pack (B)	120	400
	ISO Spec.: 90, 100, 110, 120, 130, 140		
1A2662-A	Slide Pack (A)	60	600

Ref.	Description	Pcs / Box	Boxes / Case
	ISO Spec.: 15, 20, 25, 30, 35, 40		
1A2680-A	Slide Pack (A)	200	600
1A2680-B	Square Tube Pack (B)	200	400
	ISO Spec.: 45, 50, 55, 60, 70, 80		
1A2681-A	Slide Pack (A)	200	600
1A2681-B	Square Tube Pack (B)	200	400
	ISO Spec.: 90, 100, 110, 120, 130, 140		
1A2682-A	Slide Pack (A)	100	600

ABSORBENT PAPER POINTS



DoTaper

GUTTA PERCHA POINTS

with Length Mark

Sizes available: F1, F2, F3, F4, F5.



DoTaper

PAPER POINTS

with Length Mark

Sizes available: F1, F2, F3, F4, F5.



Ref.	Description	Pcs / Box
1A2691	DoTaper Gutta Percha Points single or assorted sizes packing	60
1A2696	DoTaper Paper Points single or assorted sizes packing	60

Standardized Points (Accessory)

Notes: All dimension to be measured to an accuracy 0.05mm.

A tolerance of $\pm 0.05\text{mm}$ applies to D3, D16. Taper proportion is 0.02mm per 1mm at uniform taper.

Overall length is not less than $28\text{mm} \pm 0.1\text{mm}$ unless otherwise specified.

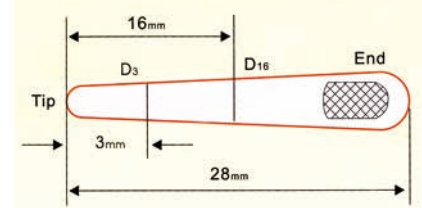

SIZE	PROJECTED DIAMETER AT THE TIP	DIA.D3 3mm FROM TIP	DIA.D16 Tol.16mm FROM TIP	Tol.	SIZE	PROJECTED DIAMETER AT THE TIP	DIA.D3 3mm FROM TIP	Tol.	DIA.D3 3mm FROM TIP	Tol.
15	0.15	0.21	0.47	± 0.05	60	0.60	0.66	± 0.07	0.92	± 0.07
20	0.20	0.26	± 0.05 0.52		70	0.70	0.76		1.02	
25	0.25	0.31	0.57		80	0.80	0.86		1.12	
30	0.30	0.36	0.62	± 0.07	90	0.90	0.96	± 0.07	1.22	± 0.07
35	0.35	0.41	0.67		100	1.00	1.06		1.32	
40	0.40	0.46	0.72		110	1.10	1.16		1.42	
45	0.45	0.51	± 0.07 0.77		120	1.20	1.26		1.52	
50	0.50	0.56	0.82		130	1.30	1.36		1.62	
55	0.55	0.61	0.87		140	1.40	1.46		1.7	

COLOR CODED GREATER TAPER GUTTA PERCHA POINTS

Ideal for obturating root canals which have been prepared with GT files, profile, Quantecs etc, Greater Taper 0.04 and 0.06 are available in assorted or individual sizes, at the top of points (d1), the diameter corresponds to the ISO sizes, but then the conicity is greater than ISO points.

Ref.	Descripti	Pcs / Box	Boxes / Case
1A2665	0.04 greater taper size No. 15, 20, 25, 30, 35, 40	60	600
1A2666	0.06 greater taper size No. 15, 20, 25, 30, 35, 40	60	600

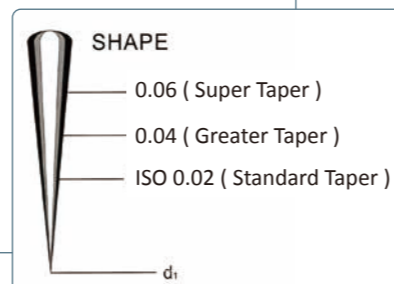

ENDO ORGANIZER GP / PP MIXTURE

Endo Aide Organizer (C)

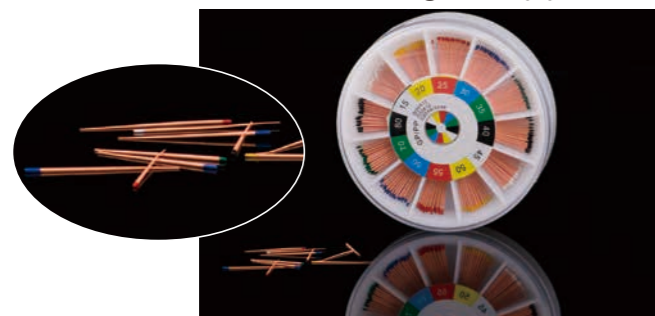

Ref.	Description	Pcs / Box	Boxes / Case
1A2685	GP 15-40#, PP 15-40#	GP-120pcs PP-200pcs	60
1A2686	GP 15-40#, PP 15-40#	GP-240pcs PP-400pcs	60

ENDO CONTAINER COMPLETE For Endo File and GP/PP

Ref.	Description	Pcs / Box	Boxes / Case
1A2690	Size: #15 - #100	1	100



NON-STANDARDIZED POINTS

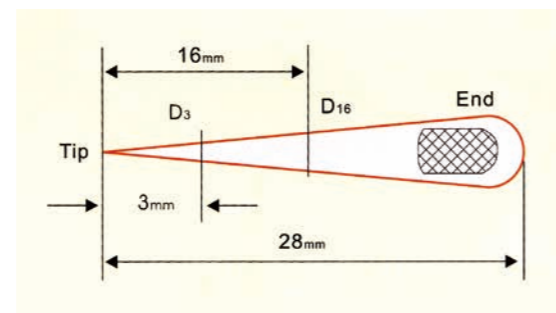

• Note: A tolerance of $\pm 0.05\text{mm}$ applies to D3, D16. Taper proportion is variable dependent upon nominal size but is of uniform taper.
 • Overall length is $28\text{mm} \pm 0.1\text{mm}$ unless other specifies
 • Packing: 100Pcs / Box

Ref.	Description	Dia. D3 3mm from tip(mm)	Dia. D16 16mm from tip(mm)
1A2667	XF (Extra-Fine)	0.20	0.45
1A2668	FF (Fine-Fine)	0.24	0.56
1A2669	MF (Medium-Fine)	0.27	0.68
1A2670	F (Fine)	0.30	0.80
1A2671	FM (Fine-Medium)	0.35	0.88

Ref.	Description	Dia. D3 3mm from tip(mm)	Dia. D16 16mm from tip(mm)
1A2672	M (Medium)	0.40	1.10
1A2673	ML (Medium-Large)	0.43	1.25
1A2674	L (Large)	0.49	1.55
1A2675	XL (Extra-Large)	0.52	1.60

NITI / STAINLESS STEEL ENDO FILE

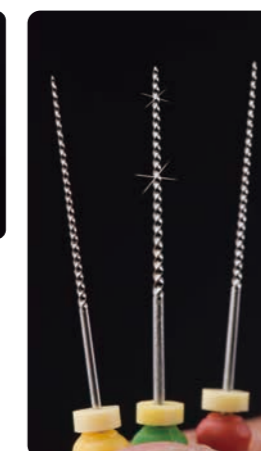

New Arrival
Hand-use Endo Files with Scale End

- High Flexibility, especially suit for complicated root canal structure
- Special cutting edge, with high cutting efficiency
- High resistance to wear, with long usage life
- Original manufacturing technology, at the leading level in NiTi industry
- Size: #15(white), #20(yellow), #25(red), #30(blue), #35(green), #40(black) ISO Size
- Length (mm): 21, 25, 28, 31
- Package: 6 pcs / box, available in individual and assorted size

More efficient, more accurate.

Ref.	Description	Pcs / Pkt
1A2326	Niti file, single or assorted sizes packing	6
1A2327	Stainless steel, single or assorted sizes packing	6

NITI ENDO FILE

Ref.	Description (Niti Endo File)	Pcs / Box
1A2200	Hand use H file (ISO #15-40, length 21mm)	6
1A2201	Hand use H file (ISO #15-40, length 25mm)	6
1A2202	Hand use H file (ISO #08, length 21mm)	6
1A2203	Hand use H file (ISO #08, length 25mm)	6
1A2204	Hand use H file (ISO #10, length 21mm)	6
1A2205	Hand use H file (ISO #10, length 25mm)	6
1A2206	Hand use H file (ISO #45-80, length 21mm)	6
1A2207	Hand use H file (ISO #45-80, length 25mm)	6

Ref.	Description (Niti Endo File)	Pcs / Box
1A2260	Hand use Spreader file (ISO #15-40, length 21mm)	6
1A2261	Hand use Spreader file (ISO #15-40, length 25mm)	6
1A2262	Hand use Spreader file (ISO #08, length 21mm)	6
1A2263	Hand use Spreader file (ISO #08, length 25mm)	6
1A2264	Hand use Spreader file (ISO #10, length 21mm)	6
1A2265	Hand use Spreader file (ISO #10, length 25mm)	6
1A2266	Hand use Spreader file (ISO #45-80, length 21mm)	6
1A2267	Hand use Spreader file (ISO #45-80, length 25mm)	6

Ref.	Description (Niti Endo File)	Pcs / Box
1A2220	Hand use K file (ISO #15-40, length 21mm)	6
1A2221	Hand use K file (ISO #15-40, length 25mm)	6
1A2222	Hand use K file (ISO #08, length 21mm)	6
1A2223	Hand use K file (ISO #08, length 25mm)	6
1A2224	Hand use K file (ISO #10, length 21mm)	6
1A2225	Hand use K file (ISO #10, length 25mm)	6
1A2226	Hand use K file (ISO #45-80, length 21mm)	6
1A2227	Hand use K file (ISO #45-80, length 25mm)	6

Ref.	Description (Niti Endo File)	Pcs / Box
1A2280	Hand use Plugger file (ISO #15-40, length 21mm)	6
1A2281	Hand use Plugger file (ISO #15-40, length 25mm)	6
1A2282	Hand use Plugger file (ISO #08, length 21mm)	6
1A2283	Hand use Plugger file (ISO #08, length 25mm)	6
1A2284	Hand use Plugger file (ISO #10, length 21mm)	6
1A2285	Hand use Plugger file (ISO #10, length 25mm)	6
1A2286	Hand use Plugger file (ISO #45-80, length 21mm)	6
1A2287	Hand use Plugger file (ISO #45-80, length 25mm)	6

Ref.	Description (Niti Endo File)	Pcs / Box
1A2240	Hand use Reamer file (ISO #15-40, length 21mm)	6
1A2241	Hand use Reamer file (ISO #15-40, length 25mm)	6
1A2242	Hand use Reamer file (ISO #08, length 21mm)	6
1A2243	Hand use Reamer file (ISO #08, length 25mm)	6
1A2244	Hand use Reamer file (ISO #10, length 21mm)	6
1A2245	Hand use Reamer file (ISO #10, length 25mm)	6
1A2246	Hand use Reamer file (ISO #45-80, length 21mm)	6
1A2247	Hand use Reamer file (ISO #45-80, length 25mm)	6

Ref.	Description (Niti Endo File)	Pcs / Box
1A2300	Engine use H file (ISO #15-40, length 21mm)	6
1A2301	Engine use H file (ISO #15-40, length 25mm)	6
1A2302	Engine use K file (ISO #15-40, length 21mm)	6
1A2303	Engine use K file (ISO #15-40, length 25mm)	6
1A2304	Engine use Reamer file (ISO #15-40, length 21mm)	6
1A2305	Engine use Reamer file (ISO #15-40, length 25mm)	6
1A2306	Engine use Plugger file (ISO #15-40, length 21mm)	6
1A2307	Engine use Plugger file (ISO #15-40, length 25mm)	6

STAINLESS STEEL ENDO FILE

Ref.	Description (Stainless Steel Endo File)	Pcs / Box
1A2340	Hand use H file (ISO #15-40, length 21mm)	6
1A2341	Hand use H file (ISO #15-40, length 25mm)	6
1A2342	Hand use H file (ISO #08, length 21mm)	6
1A2343	Hand use H file (ISO #08, length 25mm)	6
1A2344	Hand use H file (ISO #10, length 21mm)	6
1A2345	Hand use H file (ISO #10, length 25mm)	6
1A2346	Hand use H file (ISO #45-80, length 21mm)	6
1A2347	Hand use H file (ISO #45-80, length 25mm)	6

Ref.	Description (Stainless Steel Endo File)	Pcs / Box
1A2360	Hand use K file (ISO #15-40,length 21mm)	6
1A2361	Hand use K file (ISO #15-40,length 25mm)	6
1A2362	Hand use K file (ISO #08, length 21mm)	6
1A2363	Hand use K file (ISO #08, length 25mm)	6
1A2364	Hand use K file (ISO #10, length 21mm)	6
1A2365	Hand use K file (ISO #10, length 25mm)	6
1A2366	Hand use K file (ISO #45-80, length 21mm)	6
1A2367	Hand use K file (ISO #45-80, length 25mm)	6

Ref.	Description (Stainless Steel Endo File)	Pcs / Box
1A2370	Hand use Reamer file (ISO #15-40, length 21mm)	6
1A2371	Hand use Reamer file (ISO #15-40, length 25mm)	6
1A2372	Hand use Reamer file (ISO #08, length 21mm)	6
1A2373	Hand use Reamer file (ISO #08, length 25mm)	6
1A2374	Hand use Reamer file (ISO #10, length 21mm)	6
1A2375	Hand use Reamer file (ISO #10, length 25mm)	6
1A2376	Hand use Reamer file (ISO #45-80, length 21mm)	6
1A2377	Hand use Reamer file (ISO #45-80, length 25mm)	6

Ref.	Description (Stainless Steel Endo File)	Pcs / Box
1A2390	Hand use Spreader file (ISO #15-40, length 21mm)	6
1A2391	Hand use Spreader file (ISO #15-40, length 25mm)	6
1A2392	Hand use Spreader file (ISO #08, length 21mm)	6
1A2393	Hand use Spreader file (ISO #08, length 25mm)	6
1A2394	Hand use Spreader file (ISO #10, length 21mm)	6
1A2395	Hand use Spreader file (ISO #10, length 25mm)	6
1A2396	Hand use Spreader file (ISO #45-80, length 21mm)	6
1A2397	Hand use Spreader file (ISO #45-80, length 25mm)	6

Ref.	Description (Stainless Steel Endo File)	Pcs / Box
1A2410	Hand use Plugger file (ISO #15-40, length 21mm)	6
1A2411	Hand use Plugger file (ISO #15-40, length 25mm)	6
1A2412	Hand use Plugger file (ISO #08, length 21mm)	6
1A2413	Hand use Plugger file (ISO #08, length 25mm)	6
1A2414	Hand use Plugger file (ISO #10, length 21mm)	6
1A2415	Hand use Plugger file (ISO #10, length 25mm)	6
1A2416	Hand use Plugger file (ISO #45-80, length 21mm)	6
1A2417	Hand use Plugger file (ISO #45-80, length 25mm)	6

Ref.	Description (Stainless Steel Endo File)	Pcs / Box
1A2430	Engine use H file (ISO #15-40, length 21mm)	6
1A2431	Engine use H file (ISO #15-40, length 25mm)	6
1A2432	Engine use K file (ISO #15-40, length 21mm)	6
1A2433	Engine use K file (ISO #15-40, length 25mm)	6
1A2434	Engine use Reamer file (ISO #15-40, length 21mm)	6
1A2435	Engine use Reamer file (ISO #15-40, length 25mm)	6
1A2436	Engine use Plugger file (ISO #15-40, length 21mm)	6
1A2437	Engine use Plugger file (ISO #15-40, length 25mm)	6

HEAT ACTIVATION NITI PROTAPER FILES



- Made of high quality Niti alloy material
- Excellent flexibility, high cutting efficiency and fracture resistance
- Progressive taper design improves treatment effects, especially in tighter or more curved canals
- Recommended rotary speed: 250 - 350 r/min
- Sizes available: SX, S1, S2, F1, F2, F3, mix 6 sizes.
- Packing: 6 files per box, available of single or assorted sizes

Ref.	Description	Pcs / Box
1A2324-SX	Size: SX	6
1A2324-S1	Size: S1	6
1A2324-S2	Size: S2	6
1A2324-F1	Size: F1	6
1A2324-F2	Size: F2	6
1A2324-F3	Size: F3	6
1A2324-MIX	From SX to F3	6

ENGINE-USE NITI SUPER FILE

Ref.	Description	Pcs / Box
1A2321- SX	Similar to SX Protaper	6
1A2321- S1	Similar to S1 Protaper	6
1A2321- S2	Similar to S2 Protaper	6
1A2321- F1	Similar to F1 Protaper	6
1A2321- F2	Similar to F2 Protaper	6
1A2321- F3	Similar to F3 Protaper	6
1A2321- M	Mix of: # SX, # S1, # S2, # F1, # F2, # F3	6

Size: # SX, # S1, # S2, # F1, # F2, # F3

- Made of Niti material
- Perfect flexibility, long durability
- High cutting efficiency and fracture resistance
- Autoclavable with 134°C



ENDO FOAM

Ref.	Description	Pcs / Bag	Bags / Case
1A2500	Isosceles trapezoid	100	10
1A2501	Foam insert	48	100
1A2502	Round	48	100
1A2503	Round, bule, 65 x 8 mm	50	50
1A2505	Round, bule, 50 x 8 mm	50	50
1A2506-P	Aluminium holder with foam inside, purple		
1A2506-B	Aluminium holder with foam inside, blue		
1A2507	Peel and stick cushion, 75 x 25 x25 mm, 50 pcs/box		

More shapes and materials are available upon requests.



ENDO CASSETTE

- Size: 6.5 cm x 3.0 cm x 5.5 cm, 18 holes, stainless steel made
- Ideal for use in ultrasonic baths, disinfectors, vapor, cleaner, etc.
- A silicone cursor on the cover for counting the number of times used
- Inside ruler can measure the length of endo files during operation

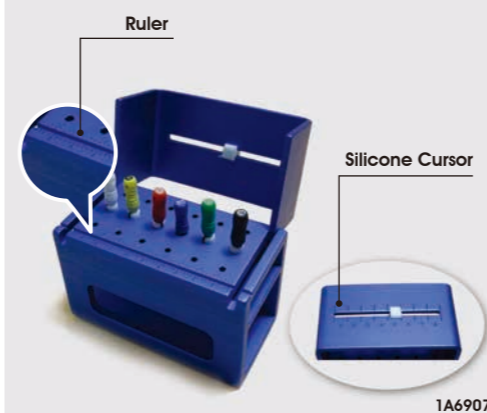

PLASTIC ENDO RULER

Gauge: 0 - 30 mm
12 - # 27
autoclavable

Ref. 1A9264



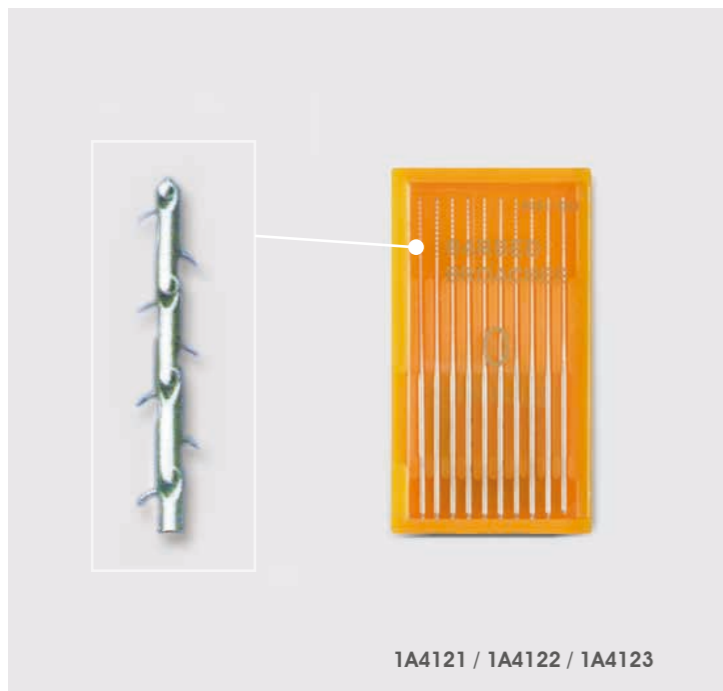

1A4121 / 1A4122 / 1A4123

BARBED BROACHES

- Made of stainless steel
- Used to remove tooth nerve and pulp tissue for root canal treatment
- Broach autoclavable with 134°C

Ref.	Description	Pcs / Box
1A4121	0#	10
1A4122	00#	10
1A4123	000#	10

SHORT BARBED BROACHES WITH HANDLE

- Made of stainless steel
- Used to remove tooth nerve and pulp tissue for root canal treatment
- The pore at the end of holder can be used to make safety chain of petiolate nerve broach, to keep from getting into trachea
- Broach autoclavable with 134°C

Length: 21 mm or 25 mm

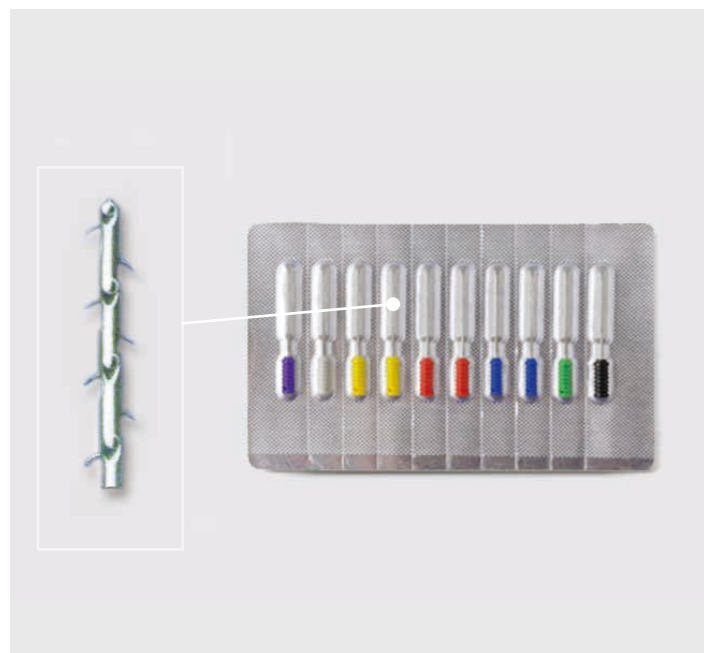
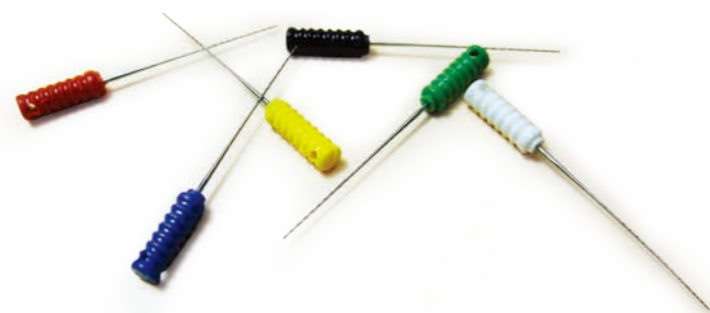

Ref.	Description	Pcs / Box
1A4100	0 #, Purple	10
1A4101	1 #, White	10
1A4102	2 #, Yellow	10
1A4103	3 #, Red	10
1A4104	4 #, Blue	10
1A4105	5 #, Green	10
1A4106	6 #, Black	10
1A4110	0 # - 6 #, Mix color	10

PEESO REAMER / GATES DRILL

- Made of medical class stainless steel
- Good flexibility and fracture resistance
- High cutting and drilling efficiency
- Recommended rotary speed (engine use): 800 - 1,200 r.p.m.
- Autoclavable with 134°C

Length: 25 mm, 28 mm or 30 mm

Single size packing is available.



Peeso Reamer

Gates Drill



Peeso Reamer

Gates Drill

Peeso Reamer

Ref.	Description	Pcs / Box
1A2440	28 mm, size # 1 - # 6	6
1A2441	32 mm, size # 1 - # 6	6

Gates Drill

Ref.	Description	Pcs / Box
1A2446	28 mm, size # 1 - # 6	6
1A2447	32 mm, size # 1 - # 6	6

DENTAL SCREW POST

Ref.	Material	Pcs / Set	Description
1A2422-120	Stainless Steel	120	Size available: S1, S2, S3, S4, S5, S6
1A2422-240		240	
1A2424-120	Gold	120	M1, M2, M3, M4, M5, M6
1A2424-240		240	
1A2426-120	Titanium	120	L1, L2, L3, L4, L5, L6
1A2426-240		240	



FIBER POST

ALL RADIOPAQUE



Refill set available

FITSPOST (THE MOST ECONOMIC GLASS FIBER POST) (REF.: 1D0000R)



- FEATURES:**
- The most economical post with pre-treatment of surface, for high strength, long term durability
 - Bonded into place for excellent retention of core / crown assembly
 - Elastic modulus similar to that of dentin, to prevent root fractures
 - Biocompatible and can not corrode
 - Packing: 6 pcs posts for each size, plus 1 pc drill for each size

	R1	R2	R3	R4
(Diameter) $\Phi 1$	1.0mm	1.2mm	1.4mm	1.6mm
(Diameter) $\Phi 2$	0.8mm	0.9mm	1.0mm	1.1mm
(Length) A	18mm	18mm	18mm	18mm
(Quantity)	6 pcs	6 pcs	6 pcs	6 pcs

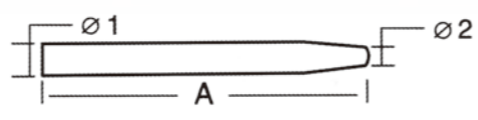

TAPERPOST (MULTI-TAPER GLASS FIBER POST) (REF.: 1D0010R)

	R1	R2	R3	R4
(Diameter) $\Phi 1$	1.14mm	1.25mm	1.4mm	1.5mm
(Diameter) $\Phi 2$	0.5mm	0.6mm	0.8mm	1.0mm
(Length) A	13.2mm	13.8mm	14.9mm	15.9mm
(Quantity)	6 pcs	6 pcs	6 pcs	6 pcs

- FEATURES:**
- Taper shaft portion enhance adaptation and dentin conservation
 - Enhanced adaptation in flared canals, polymerization shrinkage
 - Special multi-taper supply excellent bonding strength
 - Packing: 6 pcs posts for each size, plus 1 pc drill for each size

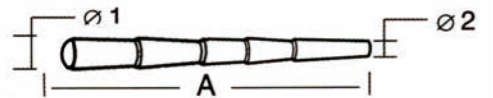
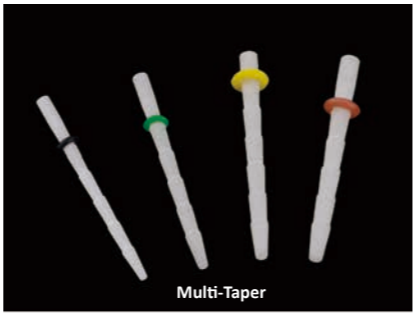

BISCONIPOST (HIGH TRANSPARENCY QUARTZ FIBER POST)(REF.: 1D0020R)

- FEATURES:**
- Double taper or double conicity, fits to realistic contours of the treated canal
 - Special design fits to complex canal
 - High resistance and fatigue strength
 - The popular clinically tested fiber post on the market
 - Packing: 6 pcs posts for each size, plus 1 pc drill for each size

	R1	R2	R3	R4
(Diameter) $\Phi 1$	1.25mm	1.4mm	1.5mm	1.65mm
(Diameter) $\Phi 2$	0.8mm	0.9mm	1.0mm	1.1mm
(Length) A	18mm	18mm	18mm	18mm
(Quantity)	6 pcs	6 pcs	6 pcs	6 pcs



FIBERLOCK POST (HIGH TRANSPARENCY QUARTZ FIBER POST) (REF.: 1D0030R)

	R1	R2	R3	R4
(Diameter) $\Phi 1$	1.14mm	1.25mm	1.4mm	1.5mm
(Diameter) $\Phi 2$	0.5mm	0.6mm	0.8mm	1.0mm
(Length) A	13.2mm	13.8mm	14.9mm	15.9mm
(Quantity)	6 pcs	6 pcs	6 pcs	6 pcs

- FEATURES:**
- Taper ball with multi-taper surface features improve retention values
 - Special shape supply good adaptation and conservative preparation
 - Low modulus of elasticity prevent the risk of root fracture
 - High resistance and fatigue strength, long term durability
 - Packing: 6 pcs posts for each size, plus 1 pc drill for each size



Aluminium Endo Disinfection Box

1A9002

Description:
72 FG; Mes.: 105 x 45 x 50 mm

Solid Holder



1A9002-W / 1A9002-B / 1A9002-R

1A9006

Description:
36 FG + 36 Endo File; Mes.: 105 x 45 x 50 mm



1A9006-W / 1A9006-B / 1A9006-R

1A9014

Description:
60 hole, 30 FG + 30 Endo File + 4 tubes (GP); Mes.: 105 x 45 x 50 mm

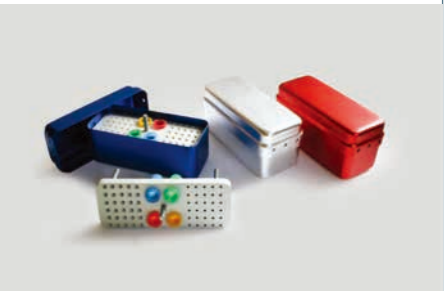

1A9014-W / 1A9014-B / 1A9014-R

Two-layer Holder

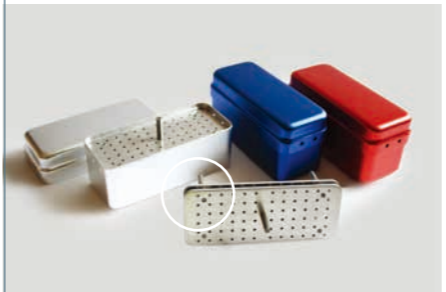

1A9002-W D / 1A9002-B D / 1A9002-R D

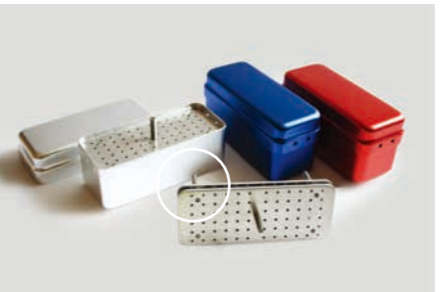

1A9006-W D / 1A9006-B D / 1A9006-R D



1A9014-W D / 1A9014-B D / 1A9014-R D

White (-W) Blue (-B) Red (-R)



1A9004

Description: 28 holes for FG+Endo File; Mes.: 55 x 40 mm

- Blue 1A9004-B
- Red 1A9004-R

Aluminium Endo Disinfection Box

1A9012

Description:
35 holes for FG + Endo File + 6 Tubes (GP),
with Endo Ruler;
Mes.: 118 x 83 x 50 mm

- White 1A9012-W Red 1A9012-R
- Blue 1A9012-B



1A9010

Description:
60 FG + 60 Endo File, with Endo Ruler;
Mes.: 118 x 83 x 50 mm

- White 1A9010-W
- Red 1A9010-R
- Blue 1A9010-B



1A9040 / Aluminium Endo Box with Lid

Description: For burs, GP, and other instruments;
Mes.: 133 x 54 x 17 mm

- White 1A9040-W Red 1A9040-R
- Blue 1A9040-B



Aluminium Scaler Tip Disinfection Box



1A9011

Description:
22 holes; Mes.: 105 x 45 x 50 mm

- White 1A9011-W
- Blue 1A9011-B
- Red 1A9011-R

Stainless Round Disinfection Box



1A9100

Description:
45 holes for FG + Endo File; Dia.: 75 mm

- Blue 1A9100-B
- Yellow 1A9100-Y

Stainless Steel Scaler and Implant Tip Box



1A9104

Description:
6 holes; Mes.: 60 x 45 x 50 mm

- White 1A9104-W
- Blue 1A9104-B
- Red 1A9104-R

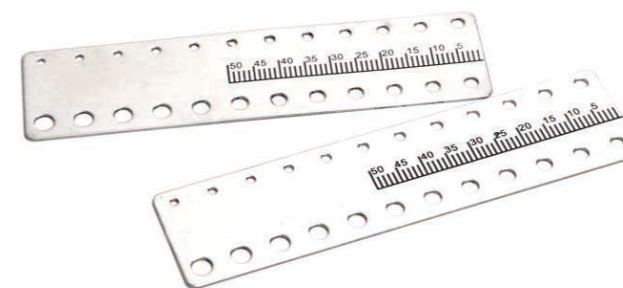

Stainless Steel Endo Ruler

Ref. 1A9250
Length: 90 mm (Gauge: 0-50 mm)

Stainless Steel Endo Ruler

Finger Type

Ref. 1A9252
Gauge: 0 - 35 mm

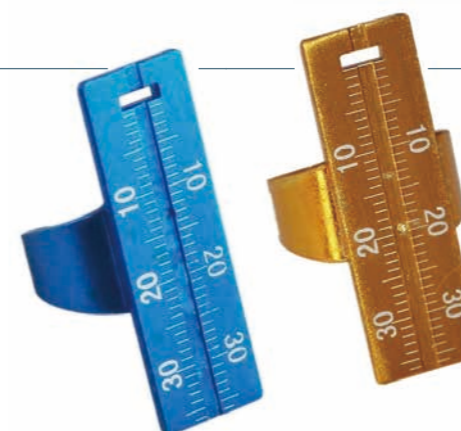

Aluminum Endo Ruler

Finger Type

Gauge: 0 - 35 mm
 Blue 1A9254-B Yellow 1A9254-Y

Aluminum Endo Ruler

Gauge: 0 - 35 mm

- Blue 1A9258-B
- Green 1A9258-G
- Yellow 1A9258-Y
- Purple 1A9258-P



DISPOSABLE IMPRESSION TRAY

- Rigid plastic frame, ergonomically designed handles for easy seating and removal
- Made of high-impact Polystyrene to ensure stability and accurate results without distortion
- Packing:
1A5901-05: 12 pcs / bag, 60 bags / case
1A5906-09: 12 pcs / bag, 100 bags / case



Ref.	Description
1A5900	#1 Large Upper
1A5901	#2 Large Lower
1A5902	#3 Medium Upper
1A5903	#4 Medium Lower
1A5904	#5 Small Upper
1A5905	#6 Small Lower
1A5906	#7 Up Right / Low Left
1A5907	#8 Up Left / Low Right
1A5908	#9 Anterior Upper
1A5909	#10 Anterior Lower

DISPOSABLE COLOR RIGID IMPRESSION TRAY

- Made of strong, rigid material to ensure consistent, distortion-free impressions
- Designed system of holes and perforations to optimize flow and retention of materials
- Pre-shaped design can be easily trimmed or flame softened to adjust for custom fit
- Special designed non-slip grips offer removal more easily and cleanly
- Compatible with wide range of impression materials
- Packing: 12 pcs / bag, 10 bags / case

Ref.	Description	Ref.	Description
1A5950	#1 Large Upper	1A5955	#6 Small Lower
1A5951	#2 Large Lower	1A5956	#7 Up L / Low R
1A5952	#3 Medium Upper	1A5957	#8 Up R / Low L
1A5953	#4 Medium Lower	1A5958	#9 Anterior Upper
1A5954	#5 Small Upper	1A5959	#10 Anterior Lower



ABS IMPRESSION TRAY

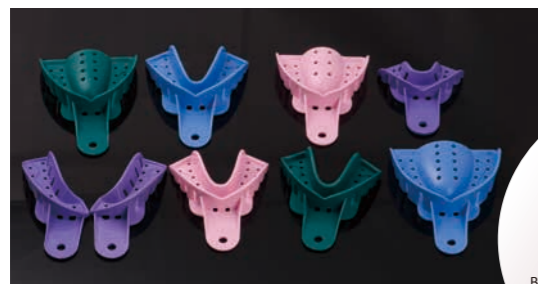

- 1A5910, 1A5911 (Green)
- 1A5912, 1A5913 (Blue)
- 1A5914, 1A5915 (Pink)
- 1A5916, 1A5917, 1A5918 (Purple)

- Made of quality ABS material, high-impact to ensure stability and accurate result without distortion, bur free
- Deliver superior performance and are compatible with all impression materials

Ref.	Description	Pcs / Bag	Bags / Case
1A5910	#1 Large Upper	12	50
1A5911	#2 Large Lower	12	50
1A5912	#3 Medium Upper	12	50
1A5913	#4 Medium Lower	12	50
1A5914	#5 Small Upper	12	50
1A5915	#6 Small Lower	12	50
1A5916	#7 Up Right / Low Left	12	100
1A5917	#8 Up Left / Low Right	12	100
1A5918	#9 Anterior	12	100

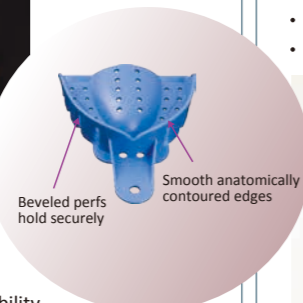

ABS MULTI COLOR-DISPOSABLE IMPRESSION TRAY

- Made of ABS material, strong construction, cold-infection
- Beveled perfs and retention rim-lock hold securely
- Non-slip handle with size # for easy identification



Ref.	Description	Pcs / Bag	Bags / Case
1A5988	#1, Extra Small Upper, Red	12	100
1A5989	#1, Extra Small Lower, Red	12	100
1A5990	#2, Small Upper, Orange	12	60
1A5991	#2, Small Lower, Orange	12	60
1A5992	#3, Medium Small Upper, Blue	12	60
1A5993	#3, Medium Small Lower, Blue	12	60
1A5994	#4, Medium Upper, Green	12	100
1A5995	#4, Medium Lower, Green	12	100
1A5996	#5, Large Medium Upper, Yellow	12	60
1A5997	#5, Large Medium Lower, Yellow	12	60
1A5998	#6, Large Upper, Purple	12	60
1A5999	#6, Large Lower, Purple	12	60



PLASTIC IMPLANT TRAY

- Made of PS material
- Designed system of holes and perforations to optimize flow and retention of materials
- Pre-shaped design can be easily trimmed or flame softened for custom fit adjustments
- Disposable or cold disinfect
- Packing: 1A5960-65: 12 pcs / bag, 40 bags / case
1A5966-68: 12 pcs / bag, 60 bags / case

Ref.	Description	Ref.	Description
1A5960	#1 Large Upper	1A5965	#6 Small Lower
1A5961	#2 Large Lower	1A5966	#7 Up R / Low L
1A5962	#3 Medium Upper	1A5967	#8 Up L / Low R
1A5963	#4 Medium Lower	1A5968	#9 Anterior
1A5964	#5 Small Upper		



DISPOSABLE IMPRESSION BITE REGISTRATION TRAY

Ref.	Description	Pcs / Bag	Bags / Case
1A5930	Small full	35	20
1A5931	Small half	50	20
1A5932	Large half	35	20
1A5933	Extra small half	50	20
1A5934	Large full	30	20

DISPOSABLE ALGI-LOCK ORTHO IMPRESSION TRAY

- Designed extra clearance needed to fit over ortho brackets and wires without tray contact
- Alginate locks hold the impression to the tray without the use of messy adhesives
- Disposable or cold disinfect

Ref.	Description	Ref.	Description
1A5970	Large upper, yellow	1A5974	Pedo medium upper, orange
1A5971	Large lower, yellow	1A5975	Pedo medium lower, orange
1A5972	Medium upper, green	1A5976	Pedo small upper, red
1A5973	Medium lower, green	1A5977	Pedo small lower, red

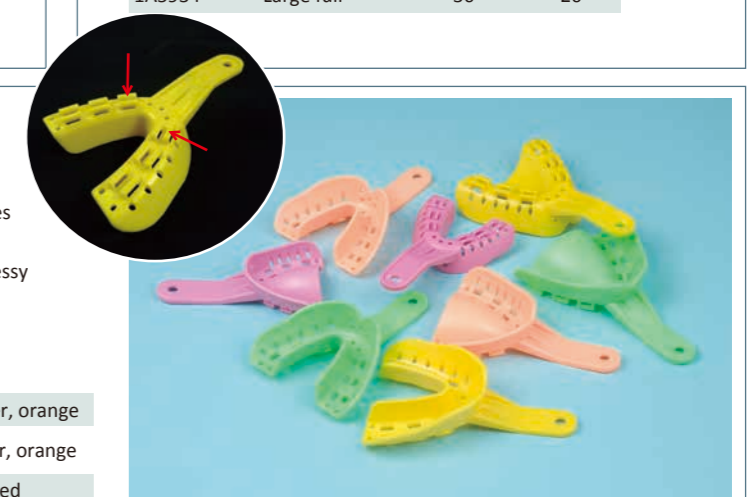

Also suits for non-ortho patients.

EXCELLENT COLOR - PLASTIC IMPRESSION TRAY

Ref.	Description
1A5980	Large upper, lavender
1A5981	Large lower, lavender
1A5982	Medium upper, sky blue
1A5983	Medium lower, sky blue
1A5984	Pedo small upper, mint green
1A5985	Pedo small lower, mint green

- Solid design take more easy for impression
- Three color coded size to fits any patient
- Disposable or cold disinfect
- Packing: 20 pcs / bag, 30 bags / case

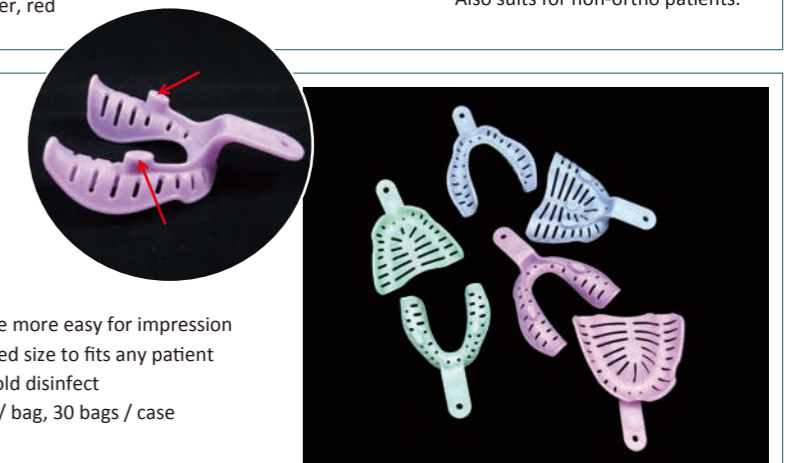

SPATULA



- Multi colors available
- Special design, comfort to use

Ref.	Description	Pcs / Bag	Bags / Case
1A6665	Sword type	1	500
1A6666	Handle type	1	500
1A6667	Hollow type	1	500
1A6668	Mixing spatula	200	20

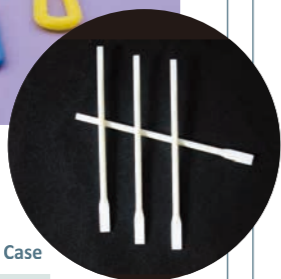

1A6668

NO-STICK SILICONE BOWL *mini*

(for acrylic mixing)



- Flexible silicone materials
- Washable for repeated use
- Five different sizes to fit different needs

Ref.	Description	Pcs / Bag	Bags / Case
1A6800	5 pcs / bag, #1 - #5	5	300
1A6801	#1, 65 x 55 mm	10	50
1A6802	#2, 50 x 40 mm	10	50
1A6803	#3, 36 x 38 mm	20	25
1A6804	#4, 31 x 23 mm	30	50
1A6805	#5, 26 x 22 mm	30	50

PVC MIXING BOWL



Ref.	Description
1A6670	Dia. 14 cm
1A6671	Dia. 12.5 cm
1A6672	Dia. 11.5 cm
1A6673	Dia. 10.5 cm
1A6674	Dia. 9 cm

Packing:
1 pc / bag, 100 bags / case

GLASS MIXING PAD

Size: 124mm x 78mm x 7mm



Ref. 1A9356

RUBBER MIXING BOWL

New



Packing: 100 pcs / case

Ref.	Description
1A6675-S	Dia.8.2 cm, Height 4.5 cm
1A6675-M	Dia.10 cm, Height 5.5 cm
1A6675-L	Dia.11.5 cm, Height 6.5 cm
1A6675-XL	Dia.13 cm, Height 8 cm

PAPER MIXING PAD



Ref.	Description	Packing
1C0471	8 cm x 6 cm	25 sheets / box
1C0481	7.5 cm x 7.5 cm	100 sheet / pad, 180 pads / case
1C0482	7.5 cm x 15 cm	100 sheet / pad, 90 pads / case

ACTIVATOR / APPLIER

- Professional design for all of **3M** Material Capsules and **GC** Material Capsules
- Pre-activates and dispense the capsule rapidly
- Autoclavable and easy to clean

Ref.	Description	Pcs / Case
1A6810	Applier	30
1A6811	Activator	30



1A6811 Activator



1A6810 Applier

IMPRESSION GUN AND MIXING TIP HOLDER



Gun holder x 2
+
mixing tip container x 2



Gun holder x 4
+
mixing tip container x 4

AMALGAM CARRIER

- Injection molded from a self-lubricating high-tech durable plastic
- Excellent for use with composites, glass ionomers and alloys
- Packing: 100 pcs / bag, 10 bags / case



Ref. 1A6681

CAPSULE DISPENSER GUN

- Easier for placing favorite composite resins, cements, glass ionomers and impression materials by right leverage feature
- Designed friction-lock barrel allows for easy loading of all standard material capsules
- Packing: 1 pc / bag, 160 bags / case



Ref. 1A6682

CAPSULE WITH CAP

1 set including: 1 capsule + 1 black cap + 1 white cap
Packing: 100 sets / bag



Ref. 1A6683

DISPOSABLE DENTAL NEEDLE (Sterilized)

MONOJECT TYPE

- New design, universal work for both *Imperial* and *Metric* Standard
- Improved needle and hub material reduce the chance of needle breakage
- Ideal tip sharpness, provide maximum patient comfort
- Every needle is individually packed and sterilized



REGULAR INDICATING LAEBL SEAL PLUS HUB HOT SEAL

Packing: 100 pcs / box, 50 boxes / case

Ref.	Description
1A2004-B21	27G (0.40) x 21 mm
1A2004-B25	27G (0.40) x 25 mm
1A2004-B38	27G (0.40) x 38 mm
1A2005-B12	30G (0.30) x 12 mm
1A2005-B16	30G (0.30) x 16 mm
1A2005-B21	30G (0.30) x 21 mm
1A2005-B25	30G (0.30) x 25 mm
1A2005-B38	30G (0.30) x 38 mm



HUB HOT SEAL ONLY ECONOMIC TYPE

Packing: 100 pcs / box, 50 boxes / case

Ref.	Description
1A2004-A21	27G (0.40) x 21 mm
1A2004-A25	27G (0.40) x 25 mm
1A2004-A38	27G (0.40) x 38 mm
1A2005-A12	30G (0.30) x 12 mm
1A2005-A16	30G (0.30) x 16 mm
1A2005-A21	30G (0.30) x 21 mm
1A2005-A25	30G (0.30) x 25 mm
1A2005-A38	30G (0.30) x 38 mm

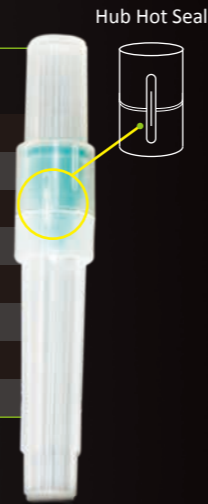

Other sizes are available upon requests.

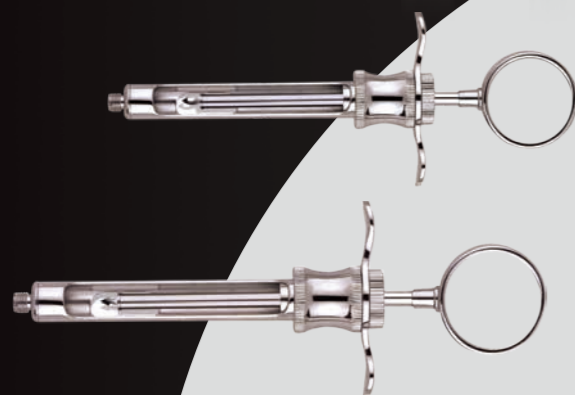

ASPIRATING SYRINGE BRASS MADE

Packing: 1 pc / bag, 200 bags / case

Ref.	Description
1A2010	1.8ml, Metric thread & Imperial screw thread, cuspidal head
1A2011	1.8ml, Metric thread & Imperial screw thread, hook head

SHARPS CONTAINER

- Economic, safe, avoid the risks of cross-infection
- Built-in hub wrench, allows one-handed, non-contact removal and disposal
- Meets all OSHA requirements

Ref.	Description
1A4350	1-Quart tray size 6-1/2" H x 3-1/2" square
1A4351	4-Quart small size 11" L x 6-3/4" W x 6" H
1A4352	8-Quart medium size 10-1/2" L x 6-3/4" W x 9-3/4" H
1A4353	16-Quart large size 10-3/4" L x 7" W x 16-1/2" H



DENTAL TRAY COVER

- Low absorbent and smooth paper, with rounded corners to provide an excellent fit for the trays
- Full size of 8-1/4" x 12-1/4", comes with different colors
- Packing: 1000 pcs / case

Ref.	Description	Pcs / Case
1A4440	White	1000
1A4441	Blue	1000
1A4442	Pink	1000
1A4443	Cream	1000



INFECTIONS WASTE BAG - Stick on

- Adheres to most work surfaces
- Size: 9" X 10"
- Packing: 200 pcs / bag, 8 bags / case

Ref.	Description
1A6748	BIO Hazard waste bag, red
1A6749	Utility waste bag, buff



DISPOSABLE FLUORIDE FOAM TRAY

Color-coded, high quality foam trays designed to offer a naturally contoured fit and exceptional comfort for fluoride treatments. Available in Dual and Single Arch

Feature:

- Comfortable and soft to wear
- Anatomically designed
- Buckle ridges for fluoride's easy access to teeth
- Long interlocking handles
- Color-coded for easy identification of sizes

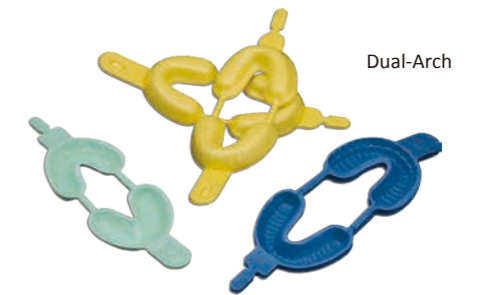

Ref.	Description	Pcs / Bag	Bags / Case
1A5940	Large	50	50
1A5941	Medium	50	60
1A5942	Small	50	80

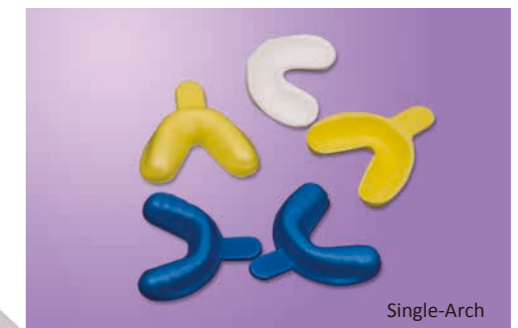

Ref.	Description	Pcs / Bag	Bags / Case
1A5943	Large	100	70
1A5944	Medium	100	90
1A5945	Small	100	110



Designed interlocking handles

CARRIER DENTURE BOX



1A6770-1A6773

- Great size, fits various needs, snap-closure cover, budget and long-lasting
- 2.12" inside depth
- Packing: 12 pcs / box, 10 boxes / case

1A6770 □Pink 1A6771 □Light blue
 1A6772 □Light yellow 1A6773 □Snow white

DISTINCT RETAINER BOX



1A6790-1A6793

- Keep appliances safe in a hard plastic box with smooth surface
- 1.0" inside depth, non-bented
- Packing: 12pcs / box, 20 boxes / case

1A6790 □Light blue 1A6791 □Pink
 1A6792 □Light yellow 1A6793 ■Green

1" = 2.54 cm

VENT-LID RETAINER CASE

Size	Ref.& Color		Packing
SMALL Inside depth: 1.06"	1A6786 □Pink	1A6787 □Light yellow	12 pcs / box, 20 boxes / case
	1A6788 □Light blue	1A6789 □White	
MEDIUM Inside depth: 1.30"	1A6780 ■Green	1A6781 ■Red	12 pcs / box, 20 boxes / case
	1A6782 ■Purple	1A6783 □Pink	
	1A6784 ■Yellow	1A6785 ■Blue	
LARGE Inside depth: 1.78"	1A6776 □Pink	1A6777 □Light blue	12 pcs / box, 10 boxes / case
	1A6778 □Light Yellow		

- Hard plastic construction, vented lids with secure snap closure
- Colorful choice
- Precise fitting, size available: small, medium and large



Medium: 1A6780-85



Small: 1A6786-89

Large: 1A6776-78

Rinsing Basket, easy to filter liquid and clean the dentures.

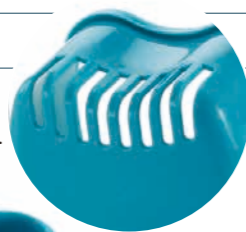

1A6797

PREMIUM DENTURE BATH CASE

- Easy-to-use package for soaking and storing one full set of denture
- Designed lift-out drain cup, keep fingers out of cleaning solution
- Leak-resistant seal
- Depth: 2.15"
- Packing: 120 pcs / case



1A6779

DENTURE BOX - ORDINARY (PP)

Ref. 1A6779

- Mix color, colors available:
 - Purple x 4 □ Pink x 4 ■ Orange x 4
 - Light blue x 4 ■ Green x 4
- Size : 8.2 x 8.5 x 2.8 cm
- Packing: 20 pcs / bag, 18 bags / ctn

DENTURE BOX WITH BASKET



1A6774

Ref. 1A6774

- Mix color, colors available:
 - Blue x 2 □ Purple x 2
 - Yellow x 2 □ White x 2
- Semicircular with inner net (8.8 x 7.5 x 6 cm)
- Packing: 8 pcs / bag, 24 bags / ctn



Ref. 1A6799

VIP DENTURE BOX

- Denture storage case with lockable design, water-proof
- Ideal for orthodontic retainers
- Cleaning brush included
- Packing: 1 pc / box, 60 boxes / ctn



DISMAN DENTURE BOX SOFT

Ref. 1A6794

- Mix color, colors available:
 - Coffee x 4 ■ Blue x 4 ■ Green x 4 ■ Yellow x 4
- Heavy gauge, soft plastic
- Size: 11 x 7.5 x 5 cm (4.33" x 2.95" x 1.96")
- Packing: 16 pcs / bag, 12 bags / ctn



Ref. 1A6796

BABY TOOTH BOX

- Tooth saver necklace in assorted colors
- Hold children's lost teeth in a locket
- Packing: 50 pcs / bag, 100 bags / ctn

ORTHO STUDY MODEL FORMER



Ref.	Description	Ref.	Description
1A6722	Large, Upper	1A6725	Large, Lower
1A6723	Medium, Upper	1A6726	Medium, Lower
1A6724	Small, Upper	1A6727	Small, Lower

- Give you nice looking models without the hassle and mess of model trimming
- Glossy inner surface makes model separation easy and speeds clean-up
- Built-in lingual contoured edge with gap for tray handle clearance
- Thicker walls maintain their shape during vibration
- Packing: 6 pcs / box, 30 boxes / case

ORTHODONTIC STRAIGHT TEETH SYSTEM

- Made of medical silicone for ultimate comfort
- Simple and effective of straightening teeth
- Wear the brace several hours each day
- Colors available: Blue and Transparent
- Packed with a retainer for each piece of brace
- Packing: 10 pcs / box, 60 boxes / case



Ref.1A6006



ARTICULATOR

Ref.	Description
1A6001	ABS material, black
1A6000	ABS material, assorted color

Packing: 2000 pcs / case



Ref. 1A6005

DISPOSABLE PLASTIC MODEL

Packing: 25 pcs / bag, 40 bags / case

PLASTIC ARTICULATOR (ABS)

Packing: 20 pcs / box, 20 boxes / ctn
Ref. 1A6003

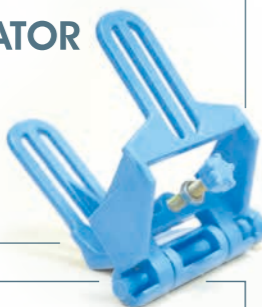

ALCOHOL LAMP (GLASS)

Ref.	Description	Pcs / Box	Boxes / Case
1A6718	Glass	1	60



ALCOHOL BLOW LAMP (PLASTIC)

Packing: 1 pc / box
Ref. 1A6719



PLASACCURATE ARTICULATOR (PS)

- Enhanced accurate pin placement due to clear plastic view
- Rotation-free designed
- Plug hinge design ensure the positive occlusal relationship and movement of upper and lower models
- Shallow retention grooves minimize dimensional change from stone expansion

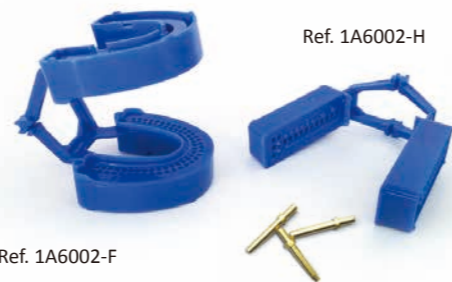

Ref. 1A6002-F

Ref. 1A6002-H

Ref.	Description	Packing
1A6002-K	Kit with full arch (anterior and posterior)	25 kits / box, 10 boxes / ctn
1A6002-F	Full arch (anterior)	50 pcs / box, 10 boxes / ctn
1A6002-H	Posterior	50 pcs / box, 10 boxes / ctn

Orthodontic Supplies

Ligature Ties



Arch Wires



Power Chains



Orthodontic Brackets



Elastic Placers



For more orthodontic products, please contact us.

EQUIPMENT



Curing Light Fiber Optic Guide

Ref.	Description	Ref.	Description
1F0046	Dia.8 mm	1F0049	Dia.11 mm
1F0047	Dia.9 mm	1F0050	Dia.12 mm
1F0048	Dia.10 mm	Other size is also available upon request	



HAND-HELD ORANGE SHIELD

- Protect dentist and assistant simultaneously from harmful UV and blue light
- Eliminates need for multiple pairs of bonding glasses
- Can be held by patient, assistant or free hand operator
- Cold disinfect only

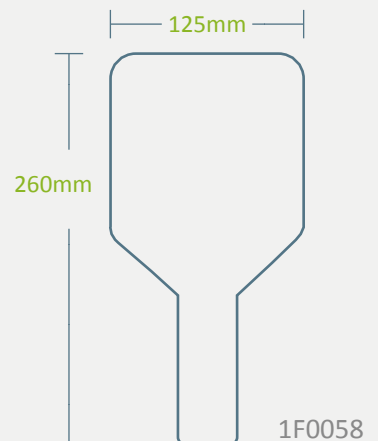

SMURFS LED CURING LIGHT (PLUG-IN POWER & BATTERY POWER)

FEATURE:

- Working time and reverse time setting
- Working modes: strong / gradually strong / flash
- High articulation optical fiber
- Automatic standby and shutdown
- Solidify all brands of composite resins
- Low battery alert

TECHNICAL DATA:

- Big power: 5 w
- Working Voltage: AC100 - 240V, 50 - 60HZ
- Wavelength: 420-480 nm
- Light power: more than 1,400 mW / cm²



1F0016

ELIGHT - X LED CURING LIGHT

FEATURE AND TECHNICAL DATA:

- Cordless operation, battery is easy for changing.
- Higher light intensity, wavelength of 385-515nm
- Apply to any kind of composite resin materials
- Light intensity 1,000 mW / cm² ± 10%
- Four working modes: full ,ramping, pulse, continues mode.
- Time setting: 5s, 10s, 15s, 20s, 120s
- The latest generation of control circuit constant light intensity output
- Large capacity of Li-ion battery(2,300 mAh)
- Very low standby power consumption, standby time can be up to 6 month



1F0052

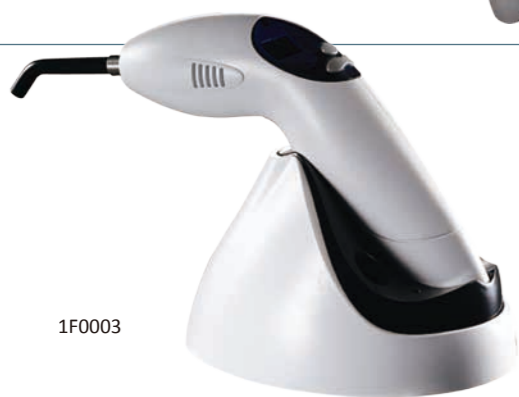

1F0003

XTECH LED CURING LIGHT (CORDLESS)

FEATURE:

- Polymerization with more than 2,000 mW / cm²
- Lithium-ion battery recharge takes 120 min, and allows up to 320 cycles without charging
- Built-in radiometer can detect power output
- 6 operating modes:

Turbo mode; Pulse mode; Ramping mode; Normal model; High mode; Whitening model

TECHNICAL DATA:

- Power supply: AC 100 - 240V, 50 - 60Hz
- Handpiece light source: super 5W LED
- Wavelength: 430 - 480 nm with peak at 460 nm
- Light intensity: Ø 8mm light guide, transparent > 2,000 mW / cm²
- Fiberglass light guide: Ø 8 mm, transparent / black can be sterilized at 135°C
- Battery capacity (cure time): approx. 45 minutes

Ref.	Description	Pcs / Ctn
1F0003	Xtech LED Curing Light	10
1F0003-BT	Chargeble battery for Xtech LED curing light	



1F0009

1F0008

ColorMAN LED CURING LIGHT

ABS WITH ALUMINUM - OXIDE COATED

Ref.	Color
1F0009-BK	Black
1F0009-SI	Silver
1F0009-BL	Blue
1F0009-OR	Orange
1F0009-YE	Yellow

FEATURE:

- High articulation optical fiber
- Automatic standby and shutdown
- Solidify all brands of composite resins
- Low battery alert
- Large-capacity lithium battery

IronMAN LED CURING LIGHT

METAL HANDPIECE WITH ALUMINUM - OXIDE COATED

Ref.	Color
1F0008-BK	Black
1F0008-SI	Silver
1F0008-BL	Blue
1F0008-OR	Orange
1F0008-YE	Yellow

TECHNICAL DATA:

- Battery Capacity: 2,200 mA / h, 3.7 v
- Big power: 5 w
- Working Voltage: AC100 - 240V, 50 - 60HZ
- Wavelength: 420 - 480 nm
- Light power: more than 1,600 mW / cm²
- Solidification time and depth: 5 s, 3 mm

INTRAOURAL CAMERA 1K0040

New

• Full Screen and Four-Quad Display

Easy to switch from full screen and four-quad display. Four-quad display can be easily accomplished with multi-frames system.

• Multiple port options :VGA/USB/RCA-Video

Powerful ARM9 processor, 1.30mega high quality imaging system
Build-in CD memory card, huge storage capacity over 12000 pictures.
Rounded edge design make dentist easy and comfortable to operate.



Powerful Imaging System Chip

High-speed ARM9 as master chip first time, capture / save / magnify / delete pictures and so on (No stuck smooth)



Mini USB port

Charge/ Read SD card/Export images, and can be used as USB camera



Lithium Battery (Alternative to connect to external power source)

Big capacity Lithium Battery, long life time, easy to use, get rid of external power limit



Massive Storage Capacity

Built-in memory card, can store 12000 above pictures, dentist can save the picture

Sensor	1/4" CMOS
Processor	ARM9
Storage Capacity	12000 photos
Power	DC5V or Lithium battery (4.2V, 800mAh)
Signal Output	RCA-VIDEO / USB2.0
Display	Full (16:9) or Four Quad
Resolution	720x576 (PAL) 640x480 (NTSC) / 720 (USB)
Lighting	6 LEDs
Operation System	Windows XP/Win7/Win8/Win8.1/Win10 (32bit&64bit)



Video Function of 720P

MAX-CLEAR INTRAORAL LED LIGHTING 1F0707

- Rechargeable & wireless illumination solution for oral examination
- Provide clear vision for dentist
- Integrated suction and biting system for easy practicing
- Soft and Safety Biteblock helps patient to keep opening mouth comfortably
- Autocalvable biteblocks



Disposable High-speed Handpiece

A viable alternative, might be the best disposable handpiece in the world!



Features:

- Disposable, provides enhanced infection control
- For a variety of procedures and applications
- Use it to cut off old crowns to protect the regular handpieces
- Sterilized self-pouch packing, avoid cross infection
- Ready for use when the package opens, save time
- Available for head with LED light or without

Noise: ≤ 65 dB
 Rotation Speed: $> 320,000$ rpm
 Radial Runout: < 0.02 mm
 Clamping Force: 22N - 45N
 Torque: $> 0.05N\cdot cm$

Non-return flap design, assures the oral pollutions will not go back to the handpiece and suction tube, to protect the chair accessories and avoid cross infection

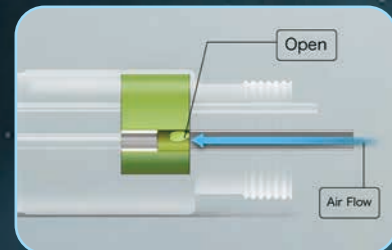

Air pressure pushes the flap open

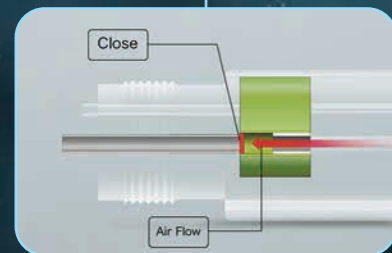

The flap prevents the retraction flowed by the negative air pressure

Almost the same holding-feel like the regular metal handpiece

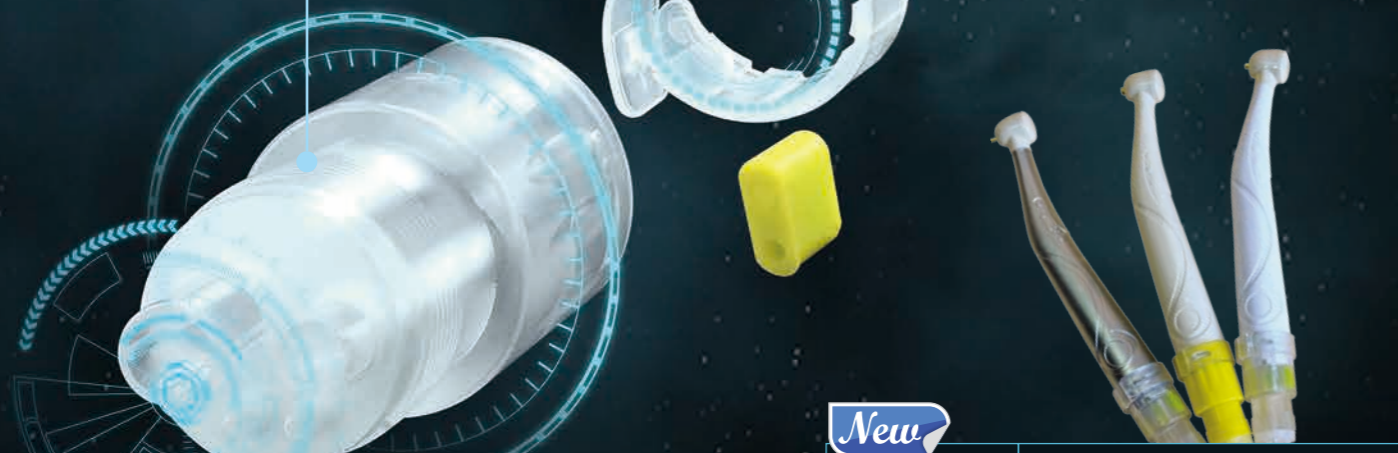

New

Colors (with 4 holes)	Ref. Code	
	Non-Led Light	With Led Light
Pearl White	1A6916-4DH	1A6916-4DHB
Ivory	1A6917-4DH	1A6917-4DHB
Silver	1A6918-4DH	1A6918-4DHB

- Spend more than \$ 2 million to manufacture this handpiece.
- Nearly 100 patents achieved, including 3 PCT.



MINICURE PIEZO MINI ULTRASONIC SCALER



Ref. 1F0037

FEATURE:

- Compact size control unit
- Simple design and easy procedure selection control
- Allows simple installation into All Dental Units
- LED Optic lighting handpiece optional

TECHNICAL DATA:

- Power supply: AC 100 - 240V, 50 / 60 Hz
- Frequency: 26 - 35 K Hz
- Size: 80 (W) x 140 (D) x 32(H) (mm)

ELASA ULTRASONIC PIEZO SCALER

FEATURE:

- Single device to cover Periodontics, Endodontic and Scaling applications
- Multiple functions with simple, easy-to-use control
- Auto-cleaning mode
- Enables to use clinical solutions during the treatment
- Readily exchangeable solutions bottle
- Automatic memory function
- Designed for easy maintenance
- Aseptic control unit design
- Lightweight, compact and high performance handpiece
- Optic handpiece available
- An extensive tip range to offer a wide variety of applications

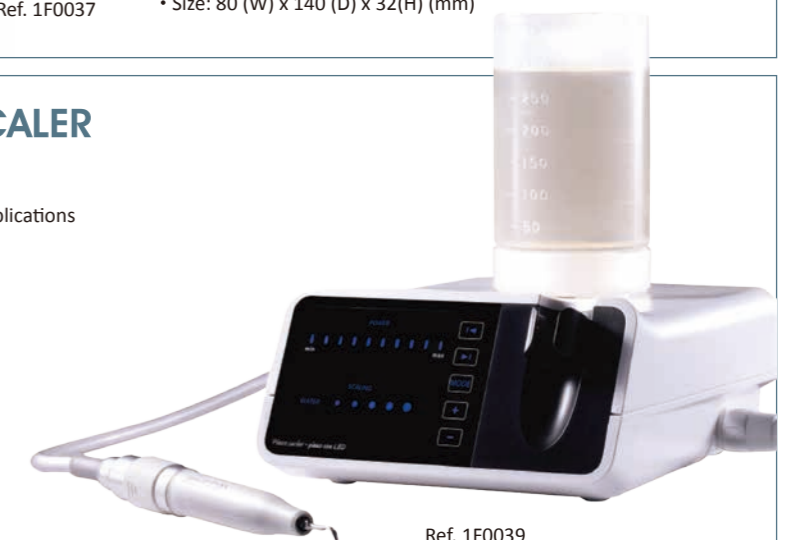

Ref. 1F0039

PIEZO ULTRASONIC SCALER (BUILT-IN TYPE)

FEATURE:

- Small size, high performance and versatility
- Optic or non-optic handpiece available
- Handpiece autoclavable up to 135°C
- Built-in automatic protection system
- Built-in feedback system assure power is accurate
- Easy integration into new and existing dental chair



Ref. 1F0034

TECHNICAL DATA:

- Power supply: AC 24V $\pm 10\%$, 50 - 60 Hz
- Power consumption: 30 W
- Equipment classification: Class II – BF Type
- Ultrasonic frequency range: 24 - 29 KHz

ULTRASONIC TIPS

SCALING

1F0073-1 Removal of supragingival and interdental calculus.

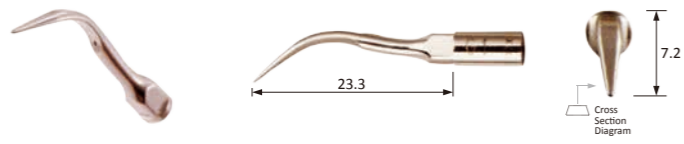

1F0073-2 Removal of heavy calculus and stains in the supragingival area.
*Place the flat-shaped head and move the tip.



1F0073-3 Removal of heavy calculus and stains in the supragingival area and between teeth.
*Place the side of the tip at the lingual sides of anterior teeth and move the tip. For other areas, place the roundshaped head and move the tip.

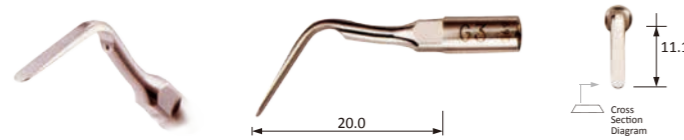

1F0073-4 The end of the tip is thin and for supragingival fine scaling and interdental scaling. The round cross-section allows tooth surfaces to be finished without causing damage.

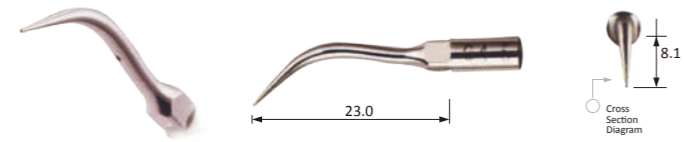

1F0073-5 Removal of calculus between molar teeth.

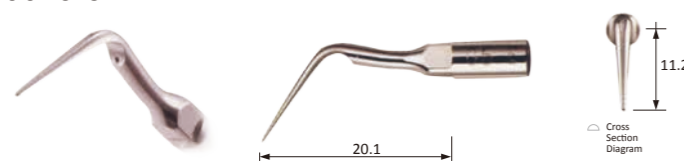

1F0073-6 Removal of supra and subgingival calculus. It provides easy access to interdental spaces and narrow pockets.

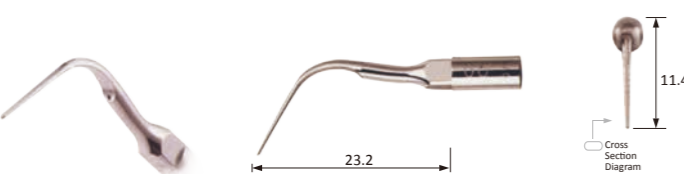

- EMS, WOODPECKER, MECTRON compatible.
- NSK, SATELEC compatible scaler tip available upon request.

SCALING

1F0073-7 The thick and flat tip is for removing supragingival interdental calculus.

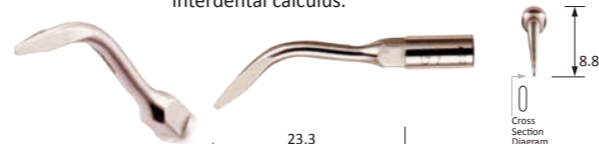

1F0073-11 The tip is similar to a Gracey Curette scaler # 1 / 2 for scaling anterior and molar teeth.



1F0073-12 Removal of supragingival calculus.

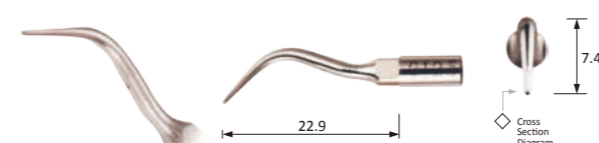

1F0073-13 Sickle Scaler type for removal of supragingival calculus. The diamond-shaped cross-section allows efficient scaling.



Cross section diagram is the image of a point 1 mm from the end. The illustrated tip diagram is four times bigger than the actual size. PIEZO Tips for NSK / Satelec / EMS / MECTRON, etc.

All PIEZO Tips are fully autoclavable.



More sizes and kits are available for most famous brands, please contact us.

D-SMART ENDODONTIC TREATMENT MINI

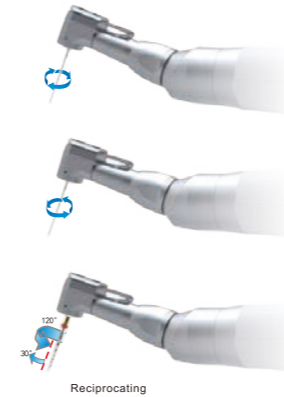

Auto reverse function

The auto reverse function activates when the preset torque level has been exceeded and can be set to operate in the following modes



File rotates clockwise when torque disappears

When the torque comes up to the limit value that has been set, file rotates counter-clockwise automatically, and will rotate clockwise again when the torque disappears



One-file reciprocation

Counter-clockwise 120°, clockwise 30°, to promote efficiency and simplify of the operation

FEATURE:

- Wireless design, light handpiece for easy operation
- LCD screen display, keyboard operating
- Original European made surgical brushless motor
- Detachable 1:1 mini contra angle, multi-angle, autoclavable
- Speed and torque can be adjusted
- Automatically shut down after 3 minutes without any operation and memory the last executed program

TECHNICAL DATA:

- Adaptor working voltage: AC 110V 50 / 60HZ; AC 220V 50 / 60HZ
- Rechargeable Li-ion battery: 3.7 V, 1,400 mAh
- 5 settings for adjustable rotational speed, ranging from 125 to 500 R.P.M.
- Torque range: 0.7 -3.7 N.cm

Ref. 1F0560



Ref.: 1F0565

D-SMART ENDODONTIC TREATMENT

FEATURE:

- Wide LCD screen for easy identification
- Original Switzerland electro-motor
- Drive-1:1 contra angle
- Adjustable speed and torque
- Auto reverse to protect the file
- Large capacity Li-ion chargeable battery, work with battery or adaptor
- Auto shutdown and memory function

TECHNICAL DATA:

- Adaptor working voltage: AC 110V 50 / 60HZ; AC 220V 50 / 60HZ
- 5 settings for adjustable rotational speed, ranging from 125 to 625 R.P.M.
- Torque range: 0.3 -5.2 N.cm



DeePEX ENDO MOTOR TREATMENT

FEATURE:

- Large LCD display, water-proof panel
- 22 settings for adjustable rotational speed, ranging from 100 to 625 R.P.M.
- Drive - 1:1 contra angle available
- 9 groups of programming data can be saved
- Reverse automatically or manually

TECHNICAL DATA:

- Adaptor working voltage: AC 110V 50 / 60HZ; AC 220V 50 / 60HZ
- Rechargeable Li-ion battery: 3.7 V x 2 pieces
- Rotational speed, ranging from 100 to 625 R.P.M.
- Torque range: 0.6 -5.2 N.cm



Ref. 1F0550



One Treatment Kit = Apex Locator + Endo Motor



Sterilizable Handpiece



Stable Foot Switch



Ref. 1F0555

DeePRO APEX LOCATOR

FEATURE:

- Large LCD display, water-proof panel
- Ensures proper determination of canal length

TECHNICAL DATA:

- Adaptor working voltage: AC 110V 50 / 60HZ; AC 220V 50 / 60HZ
- Rechargeable Li-ion battery: 3.7 V x 2 pieces

ULTRASONIC TIPS

ENDODONTICS

1F0074-4 Application for root canal cleaning and removal of foreign particles.

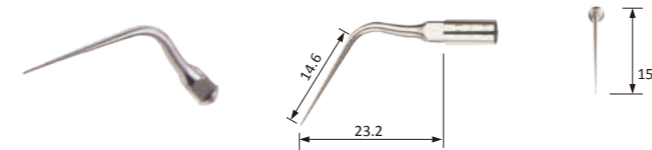

1F0074-4D Application for root canal cleaning and root canal enlargement.

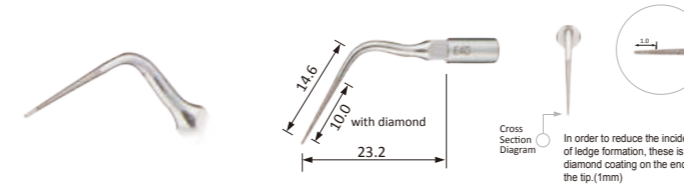

1F0074-5 Lateral condensation.

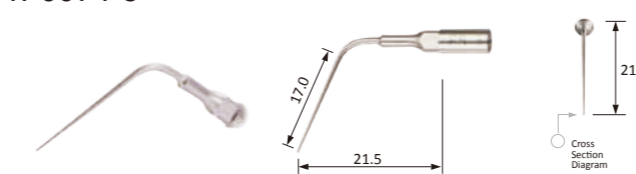

1F0074-6 Lateral condensation.

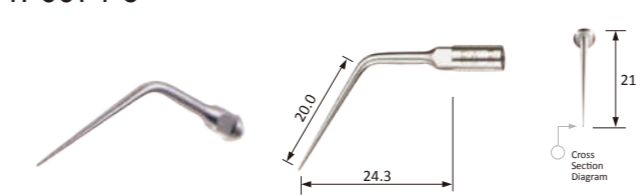

1F0074-7 Removal of filling material.

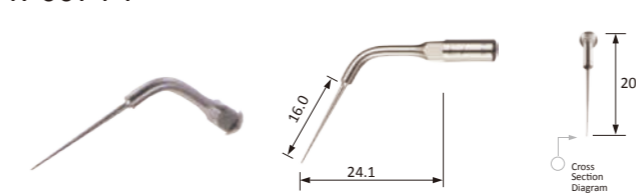

1F0074-7D Enlargement of root canal wall.

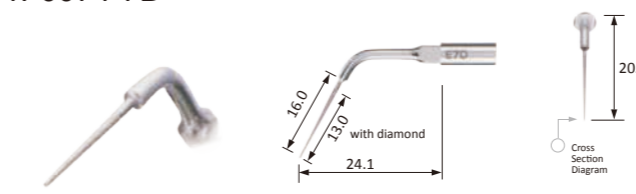

ENDODONTICS

1F0074-8 Removal of filling and foreign material.



1F0074-8D Enlargement of root canal wall.

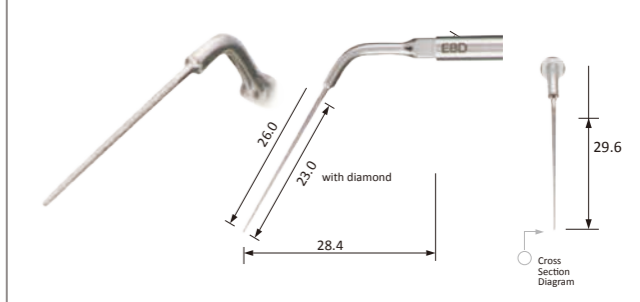

1F0074-11 120° Angle Holder for U files.

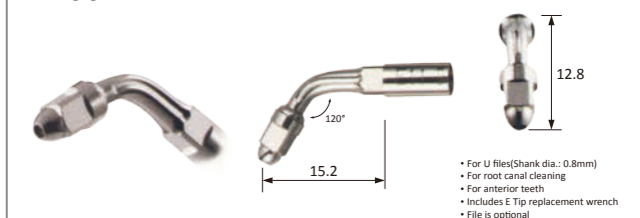

1F0076-7 95° Angle Holder for U files.

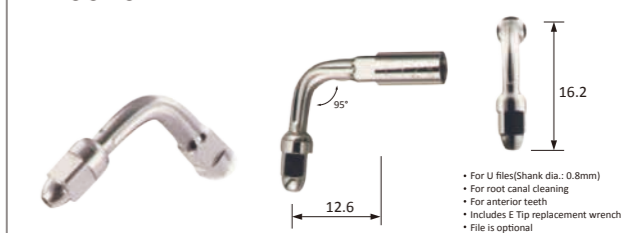

Cross section diagram is the image of a point 1 mm from the end. The illustrated tip diagram is four times bigger than the actual size. PIEZO Tips for NSK / Satelec / EMS / MECTRON, etc.

All PIEZO Tips are fully autoclavable.

More sizes and kits are available for most famous brands, please contact us.

ULTRASONIC CLEANER(ABS CASING)

Voltage: AC 100V - 120V 60Hz optional
AC 220V - 240V 50Hz / 60Hz optional



Inner tank: 15.5×9.5×5.2 cm	15.5×9.5×5.2 cm	17.5×14.5×7 cm	17.5×14.5×7 cm
Exterior size: 20×14×12.5 cm	20×14×12.5 cm	22.8×18.3×15.8 cm	22.8×18.3×15.8 cm
Power: 35 W	35 W	60 W	60 W
Frequency: 40,000 Hz	40,000 Hz	40,000 Hz	40,000 Hz
Volume: 600 ml	600 ml	1300 ml	1300 ml



1F0101-P1
Colors: Green, Blue, Purple



1F0101-P2
Colors: Blue, Green, Purple



1F0101-P3
Colors: Blue, Green, Purple



1F0101-P4
Colors: Champagne Gold, Silver Gray, White

New



1F0101-P5
With digital display and heating function
Colors: Gray, Blue, Green

Ref.	Capacity	Power	Frequency	Timing	Tank Size LxWxH mm	Net Weight	Packing
1F0101-P1	600 ml	50 w	42 KHz	60-300s adjustable	168x110x52	0.8 kg	12 pcs/case
1F0101-P2	750 ml	50 w	42 KHz	60-300s adjustable	164x140x48	1.1 kg	8 pcs/case
1F0101-P3	750 ml	50 w	42 KHz	60-300s adjustable	164x140x48	1.1 kg	8 pcs/case
1F0101-P4	1400 ml	60 w	40 KHz	60-300s adjustable	185x152x62	1.8 kg	4 pcs/case
1F0101-P4	2500 ml	70 w	40 KHz	60-300s adjustable	294x209x167	1.8 kg	4 pcs/case

STAINLESS STEEL ULTRASONIC CLEANER



Ref.	Capacity	Power	Frequency	Timing	Tank Size LxWxH mm	Net Weight	Packing
1F0103-S1	2.0 L	70 w	40 KHz	60-300s adjustable	150x135x100	1.8 kg	6 pcs/case
1F0103-S2	3.2 L	120 w	40 KHz	1-30min adjustable	240x135x100	3.9 kg	1 pcs/case
1F0103-S3	5.0 L	200 w	40 KHz	1-30min adjustable	240x135x150	4.4 kg	1 pcs/case
1F0103-S4	11.0 L	300 w	40 KHz	1-30min adjustable	300x240x150	6.9 kg	1 pcs/case

APPLICATION RANGE
The machine applies to hospitals, medical school, research, petroleum, chemical industry, light industry, metallurgy, machinery, transportation and defense industries. As equipment, instruments, electronic component, circuit boards, semiconductor silicon, the material, the electroplated parts, metal pieces, optical lenses and spare parts, audio slider, polyester filters, spinneret, the latex mold, medical equipment, glassware, gems and jewelry, watch components, precision metal pieces, bearing glib manufacture of pumps and mechanical parts and components to reduce the complexity of geometry and clean.



MIXMAX COLOR-CODED AMALGAMATOR

Mix various capsules include cements, like glass ionomer



Ref.: 1F0030-O Orange



Ref.: 1F0030-P Purple



Ref.: 1F0030-A Aqua

FEATURE:

Control Panel

- LCD screen, easy-to-read, multi-view digital display of speed and time
- Adjustable quick-entry foil keypad

Performance

- Adjustable Time (3s - 60s) and Speed (2800 r.p.m. - 4700 r.p.m.)
- Time setting with memory function
- Revolving by "8" model
- Run-silent design (less than 65db)

Safety

- Safety design, automatic shut-off if detecting lid open, self-lock clip

Design & Construction

- Microprocessor control to ensure precise, controlled, consistent mix
- Compact design to maximize bench space
- Ergonomic design for natural entry of program settings
- Light weight: 2kg
- Motor power: 20W
- Power supply: AC 220 ± 20V, 50Hz

E-Z MIX AMALGAMATOR

FEATURE:

- Time setting with memory function
- Safety design, automatic shut-off if detecting lid open
- Run-silent design (less than 65 db)
- Automatic alarm signal
- Power supply: AC 220 ± 5V, 50Hz / 110V, 60Hz
- Motor power: 20W
- Timing range: 4s - 60s
- Gross weight: 2.6 kg



Ref.: 1F0031
Blending speed ≥4,200 r.p.m.



Ref.: 1F0032
Blending speed: 4,200 r.p.m. (High); 2,800 r.p.m. (Low)

DENTAL AUTOCLAVE / STERILIZER



Ref.: 1F0300

Voltage Rating	AC220V, 50Hz
Input Power	2000W
Sterilization Temperature	121°C/134°C(Customer Definition 105°C - 134°C)
Operating Environment Temperature	5°C - 40°C
Room of Sterilization(Diameter×Depth)	250mm×450mm
Volume	23L
Overall Dimension(L×W×H)	475mm×443mm×632mm
Net Weight	57kg
Choosing Build-in Printing	Yes



Ref.: 1F0310

Power Voltage and Frequency	AC220V, 50Hz
Input Power	1800W
Sterilization Temperature	121°C/134°C(Customer Definition 105°C - 134°C)
Operating Environment Temperature	5°C - 40°C
Room of Sterilization(Diameter×Depth)	250mm×350mm
Volume	17L
Overall Dimension(L×W×H)	475mm×443mm×572mm
Net Weight	52kg
Choosing Build-in Printing	Yes

Instruction of the Operational Mode:

Pre-set procedure	Tem. (°C)	Pressure (bar)	Time of sterilization(Min.)	Working total time(Min.)	Loading	Maximum loading(kg)
1	134	2.1	4	35 - 45	Un-packed multi-loop equipment	1.00
					Packed textile	0.65
					One-layer packing solid or vacancy substances	3.00
					Double-layer packing solid or vacancy substances	1.50
2	121	1.0	20	50 - 60	Un-packed multi-loop equipment	1.00
					Packed textile	0.65
					One-layer packing solid or vacancy substances	3.00
					Double-layer packing solid or vacancy substances	1.50
3	134	2.1	4	25 - 35	Un-packed half-solid equipment	6.00
4	121	1.0	20	40 - 50	Un-packed half-solid equipment	6.00
5	134	2.1	4	20 - 30	Un-packed solid equipment	6.00
6	121	1.0	20	35 - 45	Un-packed solid equipment	6.00
7	134	2.1	18	45 - 60	Un-packed multi-loop equipment	1.00
					Packed textile	0.65
					One-layer packing solid or vacancy substances	3.00
					Double-layer packing solid or vacancy substances	1.50
8	126°C (105°C-134°C)	-	12 min. (1 - 40 min.)		Dryness time 15 minutes(3 - 25 minutes)	-

HAND-FREE ALGINATE MIXER

FEATURE:

- Patent design, hand-free, foot control
- Faster, less bubble, mix evenly
- AC 220V ± 10%, 50Hz ± 1Hz
- Rotate speed: 0 – 300 R.P.M., adjustable, foot control
- Time setting: 20 sec. with alarm lamp flash and buzzing
- Over loading automatic stopping
- Net weight: 3 kg

Ref. 1F0038



AUTOMATIC ALGINATE MIXER

FEATURE:

- Excellent design and modeling
- Electric lock and motor brake gear ensure operational security
- Powerful motor, fine viscosity and perfect mixture
- 3 programs setting for memory the mixing time (Install setting: 6, 8, 10, 12 seconds)
- No bubbles for the material when finish mixing

Technical Data:

- Voltage: AC 110V 50/60HZ; AC 220V 50/60HZ
- Power: 350 – 400 W
- Timer: 1 – 12 seconds
- Revolution: 2,900 to 3,600 R.P.M.
- Mes.: 40 x 33 x 45 cm

Ref. 1F0038-B



Ref.: 1F0091

WATER DISTILLER

Voltage Rating	AC 220V, 50Hz	AC 110V, 60Hz
Power Rating	750 W	
Capacity	4 L	
Distiller Volume	1 L/H	
Temperature Over Safety	Power-off when temperature is 160°C	
Net Weight	4 kg	



ScalerArt PROPHY JET

- Time-save, cost-save, stable
- Easy to operate and maintain
- Quick connect to major turbine couplings

Ref. Description

1F0043-M	Coupling connector with 4 holes
1F0043-B	Coupling connector with 2 holes
1F0044-M	Coupling connector with 4 holes
1F0044-B	Coupling connector with 2 holes



1F0043-M 1F0043-B

1F0044-M 1F0044-B

HANDPIECE LUBRICATION SYSTEM

FUNCTIONAL CHARACTER:

- This machine can clean and oil the parallel shank or bending handpiece accurately and easily at any time
- It has the character of high security, easily operating, easily commanding, and any person can operate it
- Three dental handpieces can be oiled and cleaned at the same time
- Swing pinion of the 1F0320 can effectively clean and oil the dental handpiece from different angles
- Having completed the procedure of the cleaning and oiling, the remained oil can be cleared by pressing the air key
- Different handpieces can be oiled by choosing the short mode, the long mode, and the longer mode
- Oil mist filtration cotton can prevent the least diffusing of the oil mist

Voltage Rating	AC 220V, 50Hz	AC 110V, 60Hz
Air Pressure	0.35-0.60 Mpa(3.5-6.0kgf/cm²)(50-80psi)	
Oil Tank Volume	350 ml	
Distiller Volume	11/H	
Overall Dimension(L x W x H)	285mm x 355mm x 275mm	
Net Weight	7.5 kg	



Ref.: 1F0320

DENTAL [X-RAY] UNIT 60KV



1F0010: Floor / Mobile Type

Features

- Advanced technology, high-efficiency, clear imaging
- Extreme low leak radial
- Smart touching button, fast and accurate to select the exposure parameter
- Develop in the room with light, imaging within one minute
- Pneumatic up-down seat, more convenient and comfortable



1F0011: Wall-fix Type

Specifications

Power supply	AC 220V ± 10%, 50HZ, 1KVA
Tube voltage	60 KV
Tube current	8 mA
Focus size	0.8 mm
Total filtration	2.5 mmAL
Exposure time	0.2 - 4.0 s
Leak radiation	Outside one meter ≤ 0.002 Mg/h (Normal standard: 0.25 Mg/h)

DENTAL [X-RAY] UNIT 70KV



1F0010-N: Floor / Mobile Type

Features

- Advanced technology, efficient integrated design, clear imaging, low radiation
- Exposure by remote control, low voltage alarm and high voltage protection
- Develop in the room with light, imaging within one minute
- Two modes of the base: Mobile and fixed; pneumatic up-down seat
- Can connect to dental digital imaging system



1F0011-N: Wall-fix Type

Specifications

Power supply	AC 220V ± 10%, 50HZ, 1KVA
Tube voltage	70 KV
Tube current	8 mA
Focus size	1.5 mm / 0.8 mm
Total filtration	2.5 mmAL
Exposure time	0.2 - 4.0 s
Leak radiation	Outside one meter ≤ 0.002 Mg/h (Normal standard: 0.25 Mg/h)

HIGH FREQUENCY DENTAL X-RAY UNIT

Features

- High frequency, smart protective measures
- Microprocessor will choose the exposure time automatically
- Can provide wide range of options
- Assures high quality, sharp and well-defined images

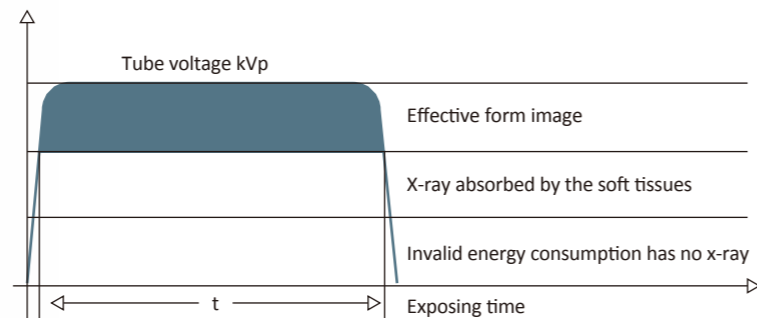

Ref. 1F0012: Floor / Mobile Type



Ref. 1F0012-W: Wall-fix Type

Specifications

Tube voltage	70 KV
Frequency	200 kHz
Time of exposure	0.02 - 4 S
Tube current	8mA
Focus size	0.8mm
Radiation leakage	≤ 0.025 mGy/h

PORTABLE DENTAL X-RAY UNIT

REF.1F0013, DC, HIGH-FREQUENCY



Optional accessory



Operation Panel

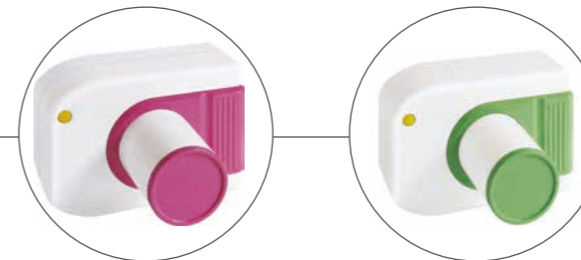

Features

- The device is DC high frequency portable dental x-ray unit, could be connected with intra-oral digital x-ray imaging system
- There are manual buttons installed on the surface of shell, operate easily. All of the components are installed in the central PC board, insulation vacuum and sealed stereotype protection make its brilliant features
- The unit mainly suitable for oral pre-treatment diagnosis of internal organization structure and root depth and so on, is indispensable in daily life clinic, especially for dental implant surgery
- The battery is durability, it can take about five hundred images after fully charged, and it can be charged and discharged for one thousand times in its life

Specifications

Tube voltage	60 KV
Exposure time	0.2-3.2 s
Tube focus	0.3 mm x 0.3 mm
Battery	DC14.8V, 6600 mAh
Charger input voltage	AC 100V - 240V ± 10%
Ambient temperature	5 - 40°C
Tube current	2 mA
Frequency	200 KHz
The distance from skin to cone	130 mm
Rated power	90 W
Output voltage	DC 16.8V
Relative humidity	< 75% RH

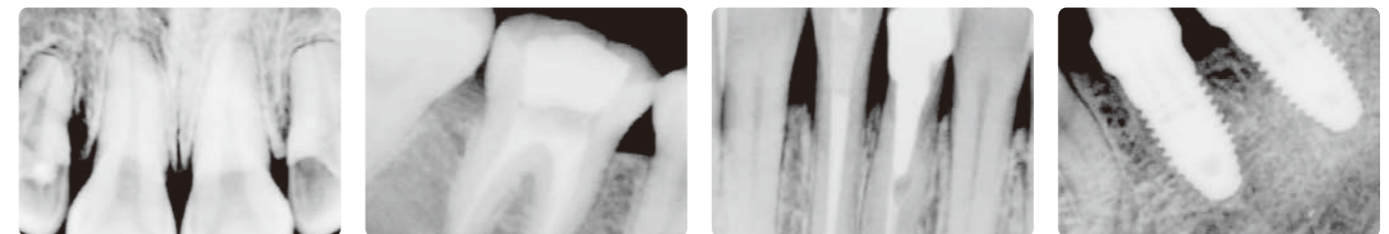

Carilo OILLESS AIR COMPRESSOR

Specific design for dentistry

An intelligent dental air compressor is an important role of a full-service dental office. Carilo oilless air compressor acts as a reliable partner of dentists, with the help of new patent technology, it supplies dental office with not only silent working environment, but also stable working performance.

TYPE: Primo, Duo, Trio, Quattro



Ref. No.	Power Supply	Power	Air Flow	Max. Workpressure	Tank Capacity	Net Weight	Packing Dimension	Noise
	(50 or 60 Hz)						MM	
	V	W	L/MIN.	MPA	L	KG		dB(A)
1F0200	220 / 110	750	90	0.8	32	28	420x420x760	58
1F0201	220 / 110	1200	180	0.8	40	40	600x320x760	62
1F0202	220 / 110	2400	320	0.8	80	80	900x510x920	63
1F0203	220 / 110	1500	200	0.8	70	50	800x330x760	60
1F0204	220 / 110	2250	280	0.8	95	60	1000x360x800	63
1F0205	220 / 110	3000	360	0.8	120	80	1200x360x800	63
1F0206	220 / 110	3600	600	0.8	150	120	1250x400x900	68
1F0207	380	4800	800	0.8	190	160	1500x400x900	68



PRIMO-ECO
(Ref.: 1F0200)

Used for Prosthodontia treatment of **1** chair unit



DUO-UTI
(Ref.: 1F0201)

Used for Prosthodontia treatment of **2** chair units at the same time



DUO-PLUS
(Ref.: 1F0202)

Used for Prosthodontia treatment of **5** chair units at the same time



DUO-POW
(Ref.: 1F0203)

Used for Prosthodontia treatment of **3** chair units at the same time

• More tank capacities are available upon request.

INDEX

1A0001-35	P01	1A5210-50	P22
1A0040-66	P02	1A5670-95	P63
1A0100-74	P03	1A5900-99	P49
1A0210-14	P03	1A5930-85	P50
1A1600-07	P03	1A5940-45	P54
1A2004-11	P53	1A6000-06	P57
1A2013-73	P25	1A6100	P30
1A2018-66	P24	1A6110-32	P34
1A2200-87	P40	1A6140-67	P31
1A2300-27	P40	1A6160-65	P32
1A2321	P42	1A6170-81	P33
1A2324-97	P41	1A6178-79	P11
1A2410-37	P41	1A6200-30	P30
1A2422-47	P44	1A6200-31	P29
1A2500-07	P42	1A6227-29	P30
1A2660-96	P38	1A6300-11	P14
1A2665-90	P39	1A6400-39	P17
1A2700-95	P07	1A6430	P14
1A3100-04	P04	1A6500-40	P17
1A3100-14	P05	1A6532-39	P18
1A3117	P04	1A6541-47	P26
1A3120-52	P06	1A6550-81	P27
1A3300-44	P08	1A6610-77	P66
1A4100-23	P43	1A6638-39	P67
1A4200-57	P09	1A6640-54	P64
1A4230-37	P10	1A6646-49	P65
1A4300-03	P10	1A6665-75	P51
1A4310-48	P35	1A6681-83	P52
1A4350-53	P54	1A6695-98	P61
1A4400-04	P10	1A6705-28	P62
1A4421-36	P18	1A6707-11	P60
1A4440-43	P54	1A6712	P34
1A5100-18	P20	1A6714-16	P28
1A5150-96	P21	1A6718-27	P57
1A5155-94	P22	1A6740-68	P19
1A5202-08	P21	1A6748-49	P54

MEMO

1A6770-97	P55	1C0303-29	P79
1A6774-99	P56	1C0330-40	P78
1A6800-05	P51	1C0456-65	P36
1A6810-11	P52	1C0471-82	P51
1A6834	P36	1C0565-68	P76
1A6850-63	P28	1D0000-30	P45
1A6866-67	P35	1F0003-52	P81
1A6870-94	P23	1F0010-11	P95
1A6900-14	P59	1F0012	P97
1A6906	P61	1F0013	P98
1A6907	P42	1F0026-27	P67
1A6916-18	P83	1F0030-32	P91
1A7010-11	P60	1F0034-39	P84
1A7051	P61	1F0038-91	P93
1A8100-48	P12	1F0043-44	P94
1A8200-19	P13	1F0046-58	P80
1A8600-18	P37	1F0073	P85
1A8640-47	P36	1F0074-76	P88
1A8901-35	P73	1F0075-78	P89
1A9002-14	P46	1F0101	P89
1A9010-40	P47	1F0103	P90
1A9100-04	P47	1F0200-07	P99
1A9106	P62	1F0300-10	P92
1A9250-58	P48	1F0320	P94
1A9264	P42	1F0500-03	P67
1A9306-08	P52	1F0550-55	P87
1A9356	P51	1F0560-65	P86
1B4000-7120	P71	1F0707	P82
1B8000-9072	P72	1J0001-40	P69
1C0000-53	P74	1K0040	P82
1C0100-52	P74	1L0016	P68
1C0248-62	P75	1L0200	P68
1C0263-83	P76	1L0320-26	P68
1C0264-66	P78		
1C0284-98	P77		
1C0301-02	P77		

Large dashed-line memo area for notes.

Thank you for being one of our most valued customers!